



SISTEMAS DE IMPLANTES IMPLANT SYSTEMS

www.gmidental.com



Implantes dentales de conexión cónica
Conical connection dental implants

Made in Spain



Índice - Summary

CARACTERÍSTICAS GENERALES

- Tratamiento superficial / estudios
- Recomendaciones de uso
- Descripción del etiquetado

SISTEMAS DE IMPLANTES

- Implantes dentales **gmi® avantgard**
- Protocolo de inserción de implantes **gmi® avantgard**
- Gama de implantes **gmi® avantgard**
- Secuencias fresado para implantes **gmi® avantgard**
- Implantes dentales **gmi® avantgard PEAK**
- Protocolo de inserción de implantes **gmi® avantgard PEAK**
- Gama de implantes **gmi® avantgard PEAK**
- Secuencias fresado para implantes **gmi® avantgard PEAK**

ADITAMENTOS GMI® AVANTGARD

- Pilares de cicatrización
- Pilares transportador
- Pilares provisionales
- Pilares inclinados
- Pilares rectos
- Base titanio
- Pilares multi-estético
- Bases bioestéticas
- Bloques pre-fresados CrCo
- Réplicas
- Tomas de impresión
- Tornillos clínica y laboratorio
- Tornillos PME y BE
- Pares recomendados de apriete

KITS QUIRÚRGICOS GMI®

- Kit quirúrgico **gmi® frontier/avantgard**
- Kit cirugía guiada **gmi® avantgard**
- Kit quirúrgico **gmi® PEAK**
- Kit cirugía guiada **gmi® avantgard PEAK**

ESPECIFICACIONES TÉCNICAS

KEY FEATURES

- Surface treatment / studies 4
- Recommendations of use 6
- Labelling description 7

IMPLANT SYSTEMS

- **gmi® avantgard** dental implants 8
- Insertion sequence for **gmi® avantgard** implants 9
- **gmi® avantgard** implants range 10
- Drilling sequences for **gmi® avantgard** implants 12
- **gmi® avantgard PEAK** dental implants 14
- Insertion sequence for **gmi® avantgard PEAK** implants 15
- **gmi® avantgard PEAK** implants range 16
- Drilling sequences for **gmi® avantgard PEAK** implants 17

GMI® AVANTGARD ATTACHMENTS

- Healing abutments 19
- Implant carrier abutments 20
- Temporary cylinders 21
- Angled abutments 22
- Straight abutments 23
- Titanium base 24
- Multi-esthetic abutments 26
- Bioesthetic bases 29
- CrCo pre-milled blanks 30
- Replicas 31
- Impression coping 32
- Clinic and laboratory screws 33
- MEA and BE screws 34
- Recommended tightening torques 35

GMI® SURGICAL KITS

- **gmi® frontier/avantgard** surgical kit 37
- **gmi® avantgard** guided surgery kit 38
- **gmi® PEAK** surgical kit 39
- **gmi® avantgard PEAK** guided surgery kit 40

TECHNICAL SPECIFICATIONS

41



- El marcado **CE 2797** aplica a productos sanitarios certificados mediante evaluación de conformidad por un Organismo Notificado bajo el marco del Reglamento (UE) 2017/745.



- El marcado **CE** (sin número de identificación) aplica a productos sanitarios autocertificados bajo el marco del Reglamento (UE) 2017/745.

- Ninguno de los dos símbolos aplica a productos excluidos del ámbito de aplicación del Reglamento (UE) 2017/745 para productos sanitarios.

- The **CE 2797** marking applies to medical devices certified through conformity assessment by a Notified Body under Regulation (EU) 2017/745.

- The **CE** marking (without an identification number) applies to self-certified medical devices under Regulation (EU) 2017/745.

- Neither of these symbols applies to products that fall outside the scope of Regulation (EU) 2017/745 for medical devices.

Tratamiento superficial ADS®

ADS® surface treatment

Para favorecer la adherencia y el crecimiento de las células óseas se ha tratado la superficie exterior del implante con el exclusivo sistema ADS® (Advanced Double-Grip Surface) que combina un microbulado con corindón blanco con un ataque ácido para obtener una rugosidad no uniforme, que maximiza la superficie de contacto entre el implante y el hueso y por tanto, mejora la estabilidad y la unión entre ellos.

To promote the adhesion and growth of bone cells, the outer surface of the implant has been treated with the exclusive ADS® treatment (Advanced Double-Grip Surface) which combines a white corundum micro-bubble treatment and acid etching, for a non-smooth roughness that maximizes the contact surface between implant and bone and therefore improves stability and adhesion between them.

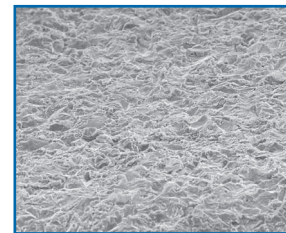
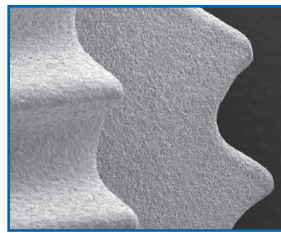
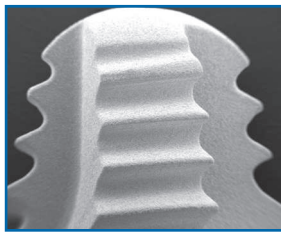

El tratamiento ADS® es el resultado de una serie de colaboraciones con institutos y universidades, así como estudios y ensayos propios que nos permiten controlar y validar la respuesta biológica óptima de la superficie del implante: se han efectuado tanto estudios químicos (estudios de dispersión rayos X para conocer la composición del implante y su superficie) como topográficos (estudios de rugosidad), así como estudios biológicos (estudios de respuesta in vivo en animales) y estudios clínicos.

The ADS® treatment is the result of a series of collaborations with institutes and universities, as well as our own research and tests, that allow us to monitor and validate the optimal biological response to the implant surface: chemical (X-ray scattering studies to find out the composition of the implant and its surface) and topography studies (roughness studies) have been carried out, as well as biological (in vivo response studies in animals) and clinical studies.

Estudios de composición

Composition studies

Los estudios efectuados por dispersión de rayos X demuestran que sobre la superficie del implante solo se encuentra titanio y oxígeno, que son los componentes básicos de la capa de óxido que se forma en el proceso de pasivado del implante, y que es la que le confiere la excelente resistencia a la corrosión.

X-ray scattering studies show that the surface of the implants is only made of titanium and oxygen, which are the basic components of the oxide layer that is formed in the implant passivation process and that gives it its excellent corrosion resistance.

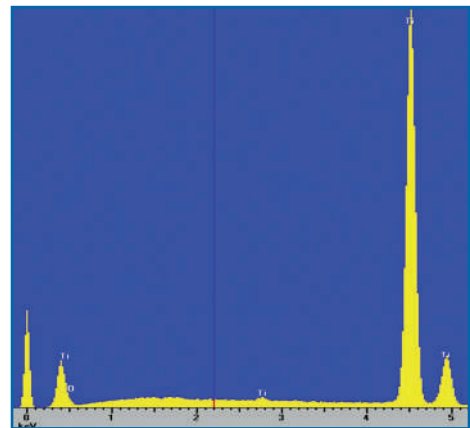

Estudios de la topografía de la superficie

Surface topography studies

Para controlar y conocer la topografía de la superficie del implante, se han efectuado estudios de rugosidad tanto con rugosímetros de contacto, como con técnicas SEM (Scanning Electron Microscope) y CLSM (Confocal Laser Scanning Microscope), permitiéndonos obtener y controlar los valores de la media aritmética de la rugosidad (Ra) dentro de los parámetros recomendados en las publicaciones internacionales.

In order to control and identify the topography of the implant surface, roughness studies were performed with profilometer, as well as with techniques such as SEM (Scanning Electron Microscope) and CLSM (Confocal Laser Scanning Microscope), allowing to obtain and control the mean roughness (Ra) values within the parameters recommended in international publications.

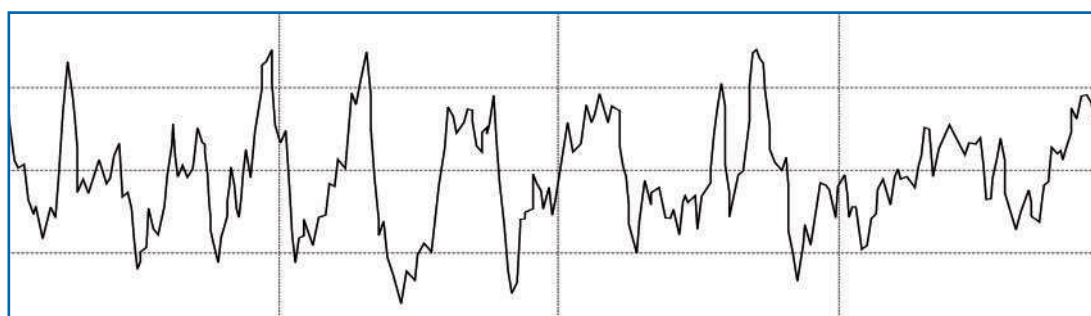

Perfil de rugosidad obtenido con HOMMEL-WERKE T1000 • Roughness profile obtained with HOMMEL-WERKE T1000.

Estudios de osteointegración

Osseointegration studies

Para conocer la respuesta biológica de los implantes **gmi**, se han efectuado estudios in vivo colocando los implantes en animales, dejándolos sin carga durante el proceso de cicatrización y efectuando un estudio histológico que demuestra la excelente respuesta de las células óseas y la osteointegración completa del implante.

To determine the biological response of **gmi** implants, in vivo studies were conducted by inserting the implants on animals, leaving them without load during the healing process and performing a histological study to prove the excellent response of the bone cells and the complete osseointegration of the implant.

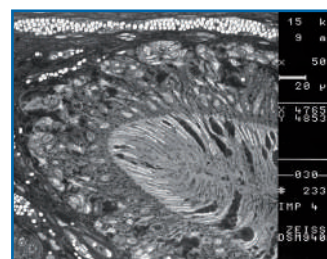
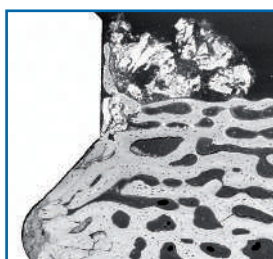
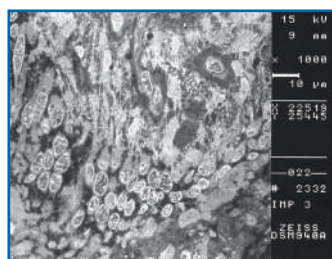

SEM-BSE: detalles ultraestructurales de las células en biofilm sobre el implante. • SEM-BSE: Ultrastructural details of cells in biofilm on the implant.

Recomendaciones de uso - Recommendations of use

La gama de implantes **gmi**® modelo **avantgard** ha sido diseñada y testada para ser colocada como restauración unitaria, con una inclinación máxima de 30 grados respecto al plano perpendicular al plano oclusal, según el siguiente diagrama.

The **gmi**® **avantgard** implant range was designed and tested to be inserted as a single restoration, with a 30-degree maximum inclination to the perpendicular plane to the occlusal plane, in accordance with the following diagram.

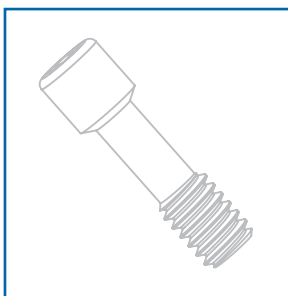
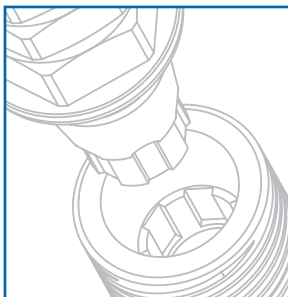
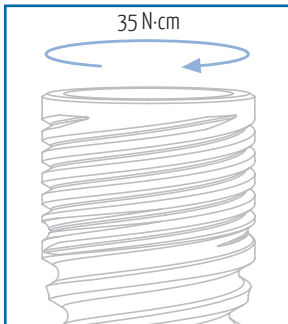
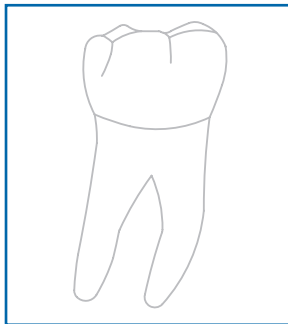

Ø3,30 - Ø3,75 mm

Incisivos
(Excepto centrales maxilares)
Incisors
(Except central maxillary incisors)



Ø4,25 mm

Caninos · Canines
Premolares · Premolars
Incisivos centrales maxilares
Central maxillary incisors



Ø4,75 - Ø5,75 mm

Molares
Molars

Los implantes **gmi**® modelo **avantgard** han sido diseñados para ser insertados aplicando un par de apriete de 35-40 N-cm, aunque pueden soportar un par máximo de apriete de 60 N-cm. **gmi**® recomienda la inserción manual del implante con la llave de carraca dinamométrica para asegurar que no se sobrepasan estos valores.

The **gmi**® **avantgard** implant range is designed to be inserted applying a 35-40 N-cm torque, although it can bear a maximum tightening torque of 60 N-cm. **gmi**® recommends manual insertion of the implant with a dynamometric ratchet wrench to ensure that these values are not exceeded.

La gama de implantes y aditamentos protésicos **gmi**® modelo **avantgard**, han sido diseñados y fabricados con unas tolerancias estudiadas para mantener unos ajustes que minimizan el juego entre los componentes, y por tanto garantizan la estabilidad de la conexión. **gmi**® recomienda utilizar aditamentos originales para asegurar el perfecto ajuste entre los componentes de la restauración.

The **gmi**® **avantgard** range of implants and prosthetic attachments are designed and manufactured with tolerances intended to maintain adjustments that minimize the clearance between components and therefore guarantee the stability of the connection. **gmi**® recommends the use of original attachments to ensure a perfect fit between the components of the restoration.

Para evitar deformaciones previas del tornillo clínica, **gmi**® recomienda reservar su uso únicamente para el apriete definitivo de la prótesis. Para realizar los ajustes de la fase protésica se recomienda utilizar el tornillo laboratorio.

To prevent prior deformation of the clinic screw, **gmi**® recommends restricting its use only for the final tightening of the prosthesis. To make adjustments during the prosthetic procedures, use of the laboratory screw is recommended.

Descripción del etiquetado - Labelling description

En la tabla se detallan todos los símbolos que aparecen en las etiquetas y cajas del sistema de implantes gmi® avantgard, con su correspondiente descripción.

In the chart are detailed all the symbols appearing on the gmi® avantgard implant system's labelling and packaging and their corresponding description.

1		Referencia - Reference
2		Número de Lote - Batch code
3		Fecha de caducidad - Used-by-date
4		Identificador único de producto Unique device identifier
5		Dispositivo médico - Medical device
6		Fabricante - Manufacturer
7		Esterilizado usando radiación gamma Sterilized using gamma radiation
8		Sistema de barrera estéril único con embalaje de protección exterior Single sterile barrier system with protective packaging outside
9		De un solo uso - Single use only
10		No utilizar si el envase está dañado o abierto Do not use if packaging is damaged or opened
11		No reesterilizar - Do not resterilize
12		RM Condicional: los dispositivos no suponen ningún peligro conocido en un entorno RM específico con condiciones de uso concretas MR Conditional: Items do not pose any known hazards in a specific MR environment with specific conditions of use.
13		Fecha de fabricación - Manufacturing date
14		Instrucciones de uso electrónicas* Electronic instructions for use*
15		Marco de conformidad europeo con intervención de un Organismo Notificado European conformity mark with a Notified Body intervention
16		Marco de conformidad europeo. Autocertificable European conformity mark. Self-certifying
17		No estéril - Non-sterile
18		Conservar en lugar protegido del sol Keep away from sunlight
19		Conservar en lugar seco Keep dry
20		Venta limitada a dentistas o médicos autorizados Sale by or on the order of a licensed dentist

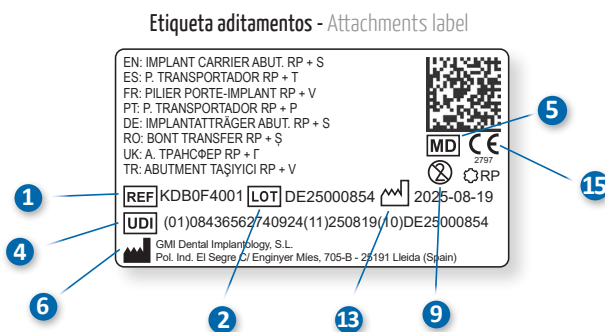
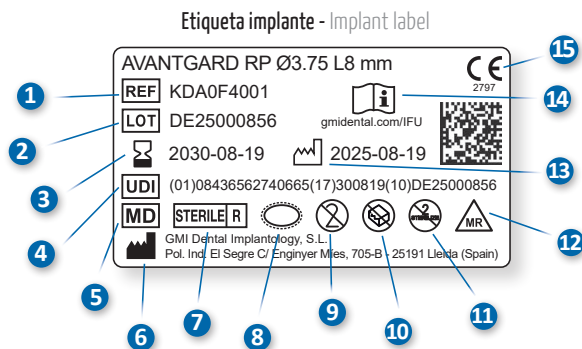

Especificaciones del DataMatrix de las etiquetas - DataMatrix specifications of labels

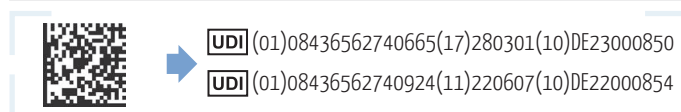

- 01 - GTIN del producto etiquetado - Tagged product GTIN
- 17 - Fecha de caducidad (año/mes/día) - Used-by-date (year/month/day)
- 11 - Fecha de fabricación (año/mes/día) - Manufacturing date (year/month/day)
- 10 - Número de Lote - Batch code

*Requisitos mínimos para abrir y descargar las instrucciones de uso electrónicas:

- Conectividad estable a internet.
- Un dispositivo con un sistema operativo moderno que admita la visualización de PDF.
- Espacio de almacenamiento adecuado en su dispositivo.
- Un navegador web como Google Chrome, Mozilla Firefox, Safari, Microsoft Edge u Opera instalado en su dispositivo.
- Una aplicación de lectura de PDF instalada en su dispositivo.

*Minimum requirements for downloading and opening the electronic instructions for use:

- Stable internet connectivity.
- A device with a modern operating system that supports PDF viewing.
- Adequate storage space on your device.
- A web browser such as Google Chrome, Mozilla Firefox, Safari, Microsoft Edge or Opera installed on your device.
- A PDF reader application installed on your device.

Implantes dentales gmi® avantgard - gmi® avantgard dental implants

Los implantes de conexión cónica gmi® modelo avantgard están mecanizados en titanio grado IV c.p. de la máxima calidad, garantizando así una gran estabilidad química y por tanto una excelente bio-compatibilidad. La capa de dióxido de titanio, que se forma en la superficie del implante después del proceso de pasivado, y el estudiado diseño del perfil exterior de la rosca aseguran una buena osteointegración y una elevada estabilidad primaria.

La rosca exterior de doble entrada del implante permite disminuir los tiempos quirúrgicos. Además, las formas redondeadas, los fresados auto-roscantes y la ligera conicidad apical facilitan la inserción del implante disminuyendo las tensiones producidas en la interfase hueso-implante, y por tanto evitando los problemas asociados al estrés de roscado.

gmi® avantgard conical connection implants are machined in c.p. grade IV titanium of the highest quality, thus ensuring a high chemical stability and excellent biocompatibility. The titanium oxide layer, that is formed on the implant surface after the passivation process, and the careful design of the outer surface of the thread, guarantee good osseointegration and high primary stability.

The external dual inlet thread of the implant helps to reduce surgery time. Moreover, the rounded shapes, self-threading millings and slight tapering facilitate implant insertion, reducing tension at the bone-implant interface and thus preventing threading stress-related problems.

Características generales

Key features

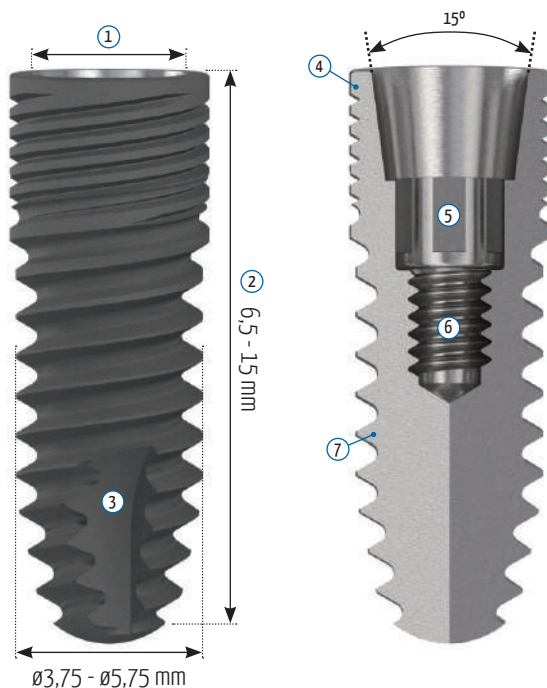

① Plataformas
NP: estrecha
RP: estándar
WP: ancha

② Longitud

③ Fresados auto-roscantes
Longitud variable
3 fresados a 120°
Ápice atraumático

④ Rosca cortical

⑤ Regatas internas
6 x 60°

⑥ Rosca interior
NP-RP: M1,6 x 0,35 mm
WP: M2,0 x 0,40 mm

⑦ Cuerpo del implante
Paso: 1,60 mm

① Platforms
NP: narrow
RP: standard
WP: wide

② Length

③ Self threading millings
Variable length
3 millings at 120°
Atraumatic tip

④ Cortical thread

⑤ Internal grooves
6 x 60°

⑥ Internal thread
NP-RP: M1.6 x 1.35 mm
WP: M2.0 x 0.40 mm

⑦ Implant body
Pitch: 1.60 mm

	NP	RP	RP	WP	WP
①	NP	RP	RP	WP	WP
②	De 10 a 15 From 10 to 15	De 8 a 15 From 8 to 15	De 6,5 a 13 From 6.5 to 13	De 6,5 a 13 From 6.5 to 13	De 6,5 a 11,5 From 6.5 to 11.5
④	Ø3,30	Ø4,00	Ø4,50	Ø5,00	Ø6,00
⑦	Ø3,30	Ø3,75	Ø4,25	Ø4,75	Ø5,75

Protocolo de inserción de implantes gmi® avantgard - Insertion sequence for gmi® avantgard implants

Los implantes de conexión cónica gmi® avantgard vienen presentados en una caja de cartón serigrafiada, en cuyo interior se encuentran las etiquetas de trazabilidad y un doble envase que contiene el sistema de implantes, siendo el envase secundario de plástico técnico y el envase primario de vidrio Pyrex para asegurar el comportamiento inerte del envase. Una vez envasados en sala blanca, son esterilizados mediante radiación gamma según normativa.

El nuevo sistema de envasado de los implantes gmi® avantgard consta de un soporte de titanio donde se aloja el implante dental preparado para ser introducido directamente en boca, utilizando la llave transportador, diseñada a tal efecto. Este nuevo sistema presenta las siguientes ventajas para el profesional: un mayor control y una mejor visibilidad del proceso de inserción del implante, una mayor facilidad de uso en espacios interdentes reducidos y una reducción en el tiempo de cirugía.*

gmi® avantgard conical connection implants are packed in a screen-printed cardboard box, with the traceability labels and a double packaging containing the implant system, with the secondary packaging made of technical plastic and the primary packaging made of Pyrex glass to ensure the inert performance of the container. Once packaged in a clean room, they are sterilized with gamma radiation according to regulations.

The new packaging system of the gmi® avantgard implants consists of a titanium support which houses the dental implant, prepared to be inserted directly into the mouth, using the implant carrier wrench, designed for this purpose. This new system offers the odontologist the following advantages: more control and a better view of the implant insertion process, it is easier to use in reduced interdental spaces and a reduction in surgery time.*



* Consultar las instrucciones de uso en formato electrónico.

1. Comprobar pegatina indicadora de diámetro y longitud del implante y abrir la caja de cartón.
2. Extraer el envase secundario y las etiquetas identificativas del producto.
3. Comprobar integridad del precinto de seguridad y desenroscar el tapón del envase secundario.
4. Extraer el envase primario del envase secundario evitando golpearlo contra una superficie rígida.
5. Extraer y guardar el tapón del envase primario, efectuando un movimiento lateral.
6. Introducir la llave de inserción encarando las regatas de la llave con las del implante.
7. Comprobar que la llave está totalmente insertada y efectuar un pequeño giro mientras se estira con suavidad el conjunto.
8. Colocar el implante en el lecho óseo aplicando un par de 35 N-cm hasta que la parte tratada quede a nivel subcrestal. Extraer la llave efectuando un movimiento axial.
9. Extraer el tapón de cierre del tapón primario, utilizando la llave de HEX-1,20 mm.
10. Roscar el tapón de cierre al implante aplicando un par máximo de 15 N-cm. Extraer llave y suturar incisión.

* Consult the instructions for use in electronic format.

1. Check sticker indicating implant diameter and length and open the carton.
2. Remove the secondary packaging and product identification labels.
3. Check the integrity of the safety seal and unscrew the plug on the secondary packaging.
4. Remove the primary packaging from the secondary packaging avoiding hitting it against a hard surface.
5. Extract and save the primary packaging plug making a lateral movement.
6. Insert the insertion wrench facing the grooves of the wrench with those of the implant.
7. Check that the wrench is fully inserted and turn slightly while gently pulling on the assembly.
8. Place the implant in the bone bed by applying a torque of 35 N-cm until the treated area is at the subcrestal level. Remove the wrench by making an axial movement.
9. Remove the cover screw from the primary packaging plug, using the HEX-1.20 mm wrench.
10. Screw the cover screw to the implant by applying a maximum torque of 15 N-cm. Remove wrench and suture the incision.

Gama de implantes gmi® avantgard - gmi® avantgard implants range



Implantes avantgard ø3,30 mm plataforma NP avantgard ø3.30 implants with NP platform

L (mm)	Ref.
10,00	KDA0F4020
11,50	KDA0F4021
13,00	KDA0F4022
15,00	KDA0F4023



Implantes avantgard ø3,75 mm plataforma RP avantgard ø3.75 implants with RP platform

L (mm)	Ref.
8,00	KDA0F4001
10,00	KDA0F4002
11,50	KDA0F4003
13,00	KDA0F4004
15,00	KDA0F4005



Implantes avantgard ø4,25 mm plataforma RP avantgard ø4.25 implants with RP platform

L (mm)	Ref.
6,50	KDA0F4006
8,00	KDA0F4007
10,00	KDA0F4008
11,50	KDA0F4009
13,00	KDA0F4010

Gama de implantes gmi® avantgard - gmi® avantgard implants range



Implantes avantgard ø4.75 mm plataforma WP avantgard ø4.75 implants with WP platform

L (mm)	Ref.
6,50	KDA0F4011
8,00	KDA0F4012
10,00	KDA0F4013
11,50	KDA0F4014
13,00	KDA0F4015



Implantes avantgard ø5.75 mm plataforma WP avantgard ø5.75 implants with WP platform

L (mm)	Ref.
6,50	KDA0F4016
8,00	KDA0F4017
10,00	KDA0F4018
11,50	KDA0F4019

Secuencias fresado para implantes gmi® avantgard - Drilling sequences for gmi® avantgard implants

A continuación se describen las secuencias de fresado para los diferentes modelos de implantes de conexión cónica y las condiciones de corte aconsejadas para su uso:

- Fresa lanza: 1200 - 1500 rpm.
- Fresa piloto: 700 - 900 rpm.
- Fresas escalonadas:
 - Ø3.00 y Ø3.50 mm → 400 - 700 rpm.
 - Ø4.00 y Ø5.10 mm → 400 - 600 rpm.
- Fresas corticales: 200 - 400 rpm.

Para fresar es necesario disponer de refrigeración externa con solución salina.

The following is a description of the drilling sequences for the different conical connection implant models, as well as the recommended drilling conditions for their use:

- Lance-shaped drill: 1200 - 1500 rpm.
- Pilot drill: 700 - 900 rpm.
- Step drills:
 - Ø3.00 & Ø3.50 mm → 400 - 700 rpm.
 - Ø4.00 & Ø5.10 mm → 400 - 600 rpm.
- Cortical drills: 200 - 400 rpm.

For drilling, external cooling with saline solution is required.

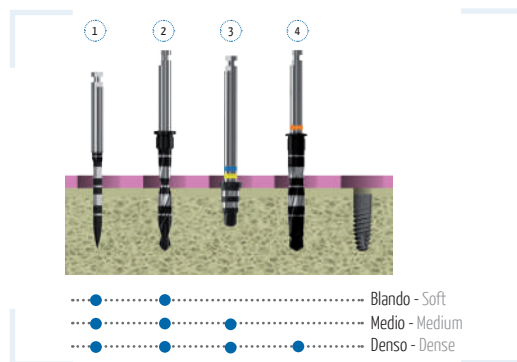

avantgard Ø3,30			
Descripción - Description			Ref.
1	Fresa lanza	Lance-shaped drill	KYFoC1225
2	Fresa piloto Ø2,50	Pilot drill Ø2.50	KYFoC2250
3	Fresa cortical Ø3,20	Cortical drill Ø3,20	KYFoC4332
4	Fresa escalonada Ø2,50/Ø3,00	Step drill Ø2.50/Ø3.00	KYFoC5130

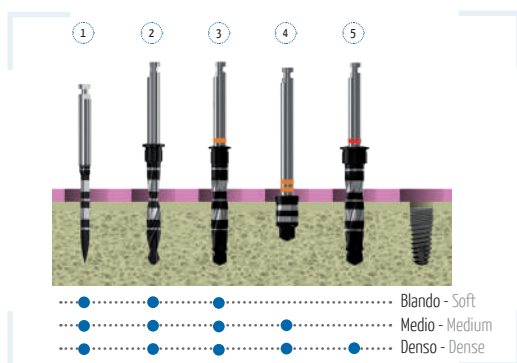

avantgard Ø3,75			
Descripción - Description			Ref.
1	Fresa lanza	Lance-shaped drill	KYFoC1225
2	Fresa piloto Ø2,50	Pilot drill Ø2.50	KYFoC2250
3	Fresa escalonada Ø2,50/Ø3,00	Step drill Ø2.50/Ø3.00	KYFoC5130
4	Fresa cortical Ø4,00	Cortical drill Ø4.00	KYFoC4340
5	Fresa escalonada Ø3,00/Ø3,50	Step drill Ø3.00/Ø3.50	KYFoC5135

Secuencias fresado para implantes gmi® avantgard - Drilling sequences for gmi® avantgard implants

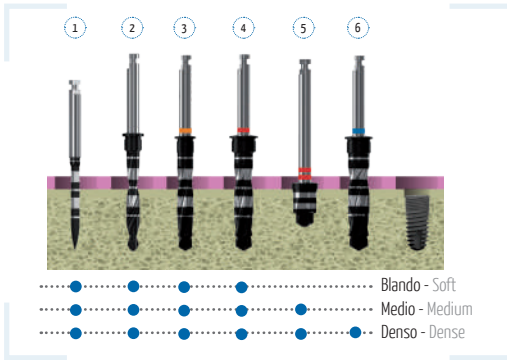

avantgard Ø4,25		
Descripción - Description		Ref.
1	Fresa lanza Lance-shaped drill	KYFoC1225
2	Fresa piloto Ø2,50 Pilot drill Ø2.50	KYFoC2250
3	Fresa escalonada Ø2,50/Ø3,00 Step drill Ø2.50/Ø3.00	KYFoC5130
4	Fresa escalonada Ø3,00/Ø3,50 Step drill Ø3.00/Ø3.50	KYFoC5135
5	Fresa cortical Ø4,50 Cortical drill Ø4.50	KYFoC4345
6	Fresa escalonada Ø3,50/Ø4,00 Step drill Ø3.50/Ø4.00	KYFoC5140

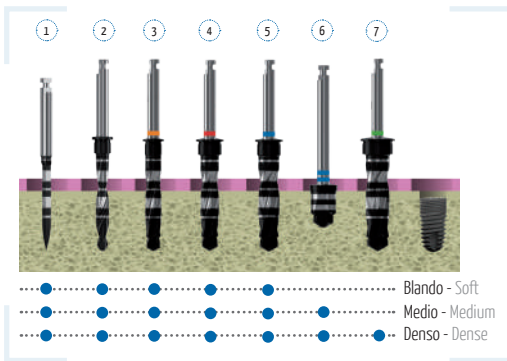

avantgard Ø4,75		
Descripción - Description		Ref.
1	Fresa lanza Lance-shaped drill	KYFoC1225
2	Fresa piloto Ø2,50 Pilot drill Ø2.50	KYFoC2250
3	Fresa escalonada Ø2,50/Ø3,00 Step drill Ø2.50/Ø3.00	KYFoC5130
4	Fresa escalonada Ø3,00/Ø3,50 Step drill Ø3.00/Ø3.50	KYFoC5135
5	Fresa escalonada Ø3,50/Ø4,00 Step drill Ø3.50/Ø4.00	KYFoC5140
6	Fresa cortical Ø4,90 Cortical drill Ø4.90	KYFoC4349
7	Fresa escalonada Ø4,00/Ø4,50 Step drill Ø4.00/Ø4.50	KYFoC5145

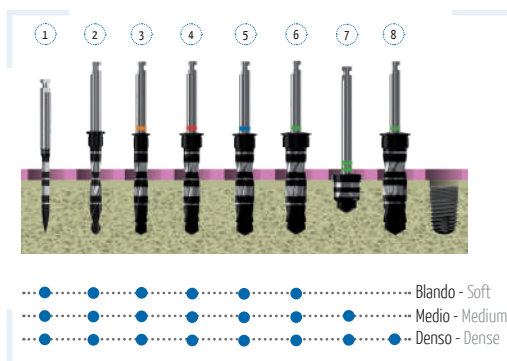

avantgard Ø5,75		
Descripción - Description		Ref.
1	Fresa lanza Lance-shaped drill	KYFoC1225
2	Fresa piloto Ø2,50 Pilot drill Ø2.50	KYFoC2250
3	Fresa escalonada Ø2,50/Ø3,00 Step drill Ø2.50/Ø3.00	KYFoC5130
4	Fresa escalonada Ø3,00/Ø3,50 Step drill Ø3.00/Ø3.50	KYFoC5135
5	Fresa escalonada Ø3,50/Ø4,00 Step drill Ø3.50/Ø4.00	KYFoC5140
6	Fresa escalonada Ø4,00/Ø4,50 Step drill Ø4.00/Ø4.50	KYFoC5145
7	Fresa cortical Ø5,90 Cortical drill Ø5.90	KYFoC4359
8	Fresa escalonada 4,50/Ø5,10 Step drill Ø4.50/Ø5.10	KYFoC5151

* El proceso recomendado por GMI® no puede sustituir el criterio y la experiencia del cirujano. - * Procedure recommended by GMI® cannot replace the judgment and the experience of the surgeon.

Implantes dentales gmi® avantgard PEAK - gmi® avantgard PEAK dental implants

Los implantes de conexión cónica gmi® modelo avantgard PEAK están mecanizados en titanio grado IV c.p. de la máxima calidad, garantizando así una gran estabilidad química y por tanto una excelente bio-compatibilidad. La capa de dióxido de titanio, que se forma en la superficie del implante después del proceso de pasivado, y el estudiado diseño del perfil exterior de la rosca aseguran una buena osteointegración y una elevada estabilidad.

La rosca exterior de doble entrada del implante permite disminuir los tiempos quirúrgicos. Además, el núcleo cónico y el perfil de rosca progresiva facilitan la inserción del implante y actúan como un compactador óseo permitiendo obtener una elevada estabilidad primaria en huesos poco densos.

gmi® avantgard PEAK conical connection implants are machined in c.p. grade IV titanium of the highest quality, thus ensuring a high chemical stability and excellent biocompatibility. The titanium oxide layer, that is formed on the implant surface after the passivation process, and the careful design of the outer surface of the thread, guarantee good osseointegration and high stability.

The external dual inlet thread of the implant helps to reduce surgery time. Moreover, the conical core and progressive thread profile facilitate implant insertion and act as a bone compactor allowing high primary stability to be obtained in sparse bones.

Características generales

Key features

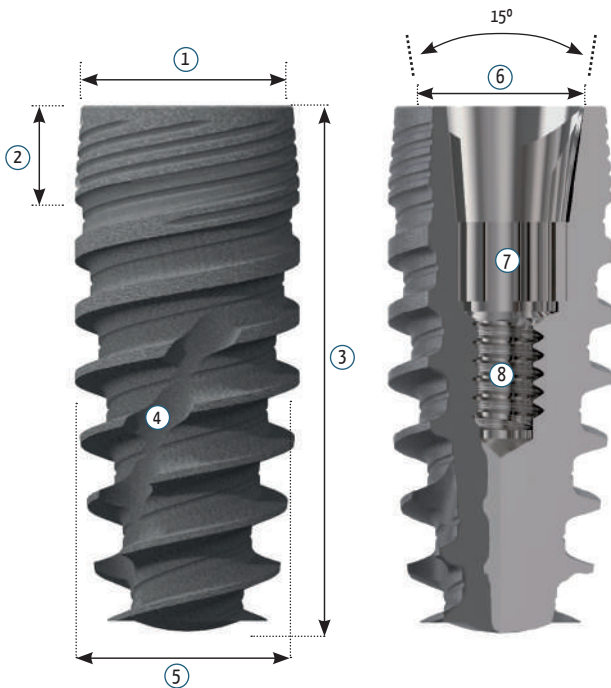

① Ø Plataforma

② Rosca cortical
1,50 mm

③ Longitud

④ Fresados auto-roscantes
Longitud variable
2 fresados a 180°
Ápice atraumático
Corte en ambas direcciones

⑤ Cuerpo del implante
Paso: 2,40 mm

⑥ Conexión
NP: estrecha
RP: estándar

⑦ Regatas internas
6 x 60°

⑧ Rosca interior
M1,6 x 0,35 mm

① Ø Platform

② Cortical thread
1.50 mm

③ Length

④ Self threading millings
Variable length
2 millings at 180°
Atraumatic tip
Cut in both directions

⑤ Implant body
Pitch: 2.40 mm

⑥ Connection
NP: narrow
RP: standard

⑦ Internal grooves
6 x 60°

⑧ Internal thread
M1.6 x 0.35 mm

	●	●	●	●
①	Ø3,30	Ø3,70	Ø4,00	Ø4,30
③	De 10 a 15 From 10 to 15	De 8 a 15 From 8 to 15	De 6,5 a 13 From 6.5 to 13	De 6,5 a 13 From 6.5 to 13
⑤	Ø3,30	Ø3,75	Ø4,25	Ø4,75
⑥	NP	RP	RP	RP

Protocolo de inserción de implantes gmi® avantgard PEAK - Insertion sequence for gmi® avantgard PEAK implants

Los implantes de conexión cónica gmi® avantgard PEAK vienen presentados en una caja de cartón serigrafiada, en cuyo interior se encuentran las etiquetas de trazabilidad y un doble envase que contiene el sistema de implantes, siendo el envase secundario de plástico técnico y el envase primario de vidrio Pyrex para asegurar el comportamiento inerte del envase. Una vez envasados en sala blanca, son esterilizados mediante radiación gamma según normativa.

El nuevo sistema de envasado de los implantes gmi® avantgard PEAK consta de un soporte de titanio donde se aloja únicamente el implante dental preparado para ser introducido directamente en boca, utilizando una única llave transportador Avantgard NP-RP, diseñada a tal efecto. Este nuevo sistema presenta las siguientes ventajas para el profesional: un mayor control y una mejor visibilidad del proceso de inserción del implante, una mayor facilidad de uso en espacios interdentes reducidos y una reducción en el tiempo de cirugía.*

gmi® avantgard PEAK conical connection implants are packed in a screen-printed cardboard box, with the traceability labels and a double packaging containing the implant system, with the secondary packaging made of technical plastic and the primary packaging made of Pyrex glass to ensure the inert performance of the container. Once packaged in a clean room, they are sterilized with gamma radiation according to regulations.

The new packaging system of the gmi® avantgard PEAK implants consists of a titanium support which only houses the dental implant, prepared to be inserted directly into the mouth, using a single Avantgard NP-RP implant carrier wrench, designed for this purpose. This new system offers the odontologist the following advantages: more control and a better view of the implant insertion process, it is easier to use in reduced interdental spaces and a reduction in surgery time.*



* Consultar las instrucciones de uso en formato electrónico.

1. Comprobar pegatina indicadora de diámetro y longitud del implante y abrir la caja de cartón.
2. Extraer el envase secundario y las etiquetas identificativas del producto.
3. Comprobar integridad del precinto de seguridad y desenroscar el tapón del envase secundario.
4. Extraer el envase primario del envase secundario evitando golpearlo contra una superficie rígida.
5. Extraer y guardar el tapón del envase primario, efectuando un movimiento lateral.
6. Introducir la llave de inserción NP-RP encarando las regatas de la llave con las del implante.
7. Comprobar que la llave está totalmente insertada y efectuar un pequeño giro mientras se estira con suavidad el conjunto.
8. Colocar el implante en el lecho óseo aplicando un par de 35 N-cm hasta que la parte tratada quede a nivel subcrestal. Extraer la llave efectuando un movimiento axial.
9. Extraer el tapón de cierre del tapón primario, utilizando la llave de HEX-1,20 mm.
10. Roscar el tapón de cierre al implante aplicando un par máximo de 15 N-cm. Extraer llave y suturar incisión.

* Consult the instructions for use in electronic format.

1. Check sticker indicating implant diameter and length and open the carton.
2. Remove the secondary packaging and product identification labels.
3. Check the integrity of the safety seal and unscrew the plug on the secondary packaging.
4. Remove the primary packaging from the secondary packaging avoiding hitting it against a hard surface.
5. Extract and save the primary packaging plug making a lateral movement.
6. Insert the NP-RP insertion wrench facing the grooves of the wrench with those of the implant.
7. Check that the wrench is fully inserted and turn slightly while gently pulling on the assembly.
8. Place the implant in the bone bed by applying a torque of 35 N-cm until the treated area is at the subcrestal level. Remove the wrench by making an axial movement.
9. Remove the cover screw from the primary packaging plug, using the HEX-1.20 mm wrench.
10. Screw the cover screw to the implant by applying a maximum torque of 15 N-cm. Remove wrench and suture the incision.

Gama de implantes gmi® avantgard PEAK - gmi® avantgard PEAK implants range

Implantes avantgard PEAK ø3,30 mm plataforma NP
 avantgard PEAK ø3.30 implants with NP platform

L (mm)	Ref.
10,00	KDA0F4816
11,50	KDA0F4817
13,00	KDA0F4818
15,00	KDA0F4819

Implantes avantgard PEAK ø3,75 mm plataforma RP
 avantgard PEAK ø3.75 implants with RP platform

L (mm)	Ref.
8,00	KDA0F4801
10,00	KDA0F4802
11,50	KDA0F4803
13,00	KDA0F4804
15,00	KDA0F4815

Implantes avantgard PEAK ø4,25 mm plataforma RP
 avantgard PEAK ø4.25 implants with RP platform

L (mm)	Ref.
6,50	KDA0F4805
8,00	KDA0F4806
10,00	KDA0F4807
11,50	KDA0F4808
13,00	KDA0F4809

Implantes avantgard PEAK ø4,75 mm plataforma RP
 avantgard PEAK ø4.75 implants with RP platform

L (mm)	Ref.
6,50	KDA0F4810
8,00	KDA0F4811
10,00	KDA0F4812
11,50	KDA0F4813
13,00	KDA0F4814

Secuencias fresado para implantes gmi® avantgard PEAK - Drilling sequences for gmi® avantgard PEAK implants

A continuación se describen las secuencias de fresado para los diferentes modelos de implantes de conexión cónica y las condiciones de corte aconsejadas para su uso:

- Fresa inicial: 1000 rpm.
- Fresa piloto: 700 - 900 rpm.
- Fresas escalonadas y cónicas:
 - Ø2,50 / Ø2,80 mm → 500 - 700 rpm.
 - Ø3,20 / Ø3,65 mm → 500 - 700 rpm.
 - Ø3,70 / Ø4,15 mm → 400 - 700 rpm.
 - Ø4,15 / Ø4,65 mm → 400 - 600 rpm.
- Fresas corticales: 200 - 400 rpm.
- Para fresar es necesario disponer de refrigeración externa con solución salina.

The following is a description of the drilling sequences for the different conical connection implant models, as well as the recommended drilling conditions for their use:

- Initial drill: 1000 rpm.
- Pilot drill: 700 - 900 rpm.
- Step and conical drills:
 - Ø2.50 / Ø2.80 mm → 500 - 700 rpm.
 - Ø3.20 / Ø3.65 mm → 500 - 700 rpm.
 - Ø3.70 / Ø4.15 mm → 400 - 700 rpm.
 - Ø4.15 / Ø4.65 mm → 400 - 600 rpm.
- Cortical drills: 200 - 400 rpm.
- For drilling, external cooling with saline solution is required.

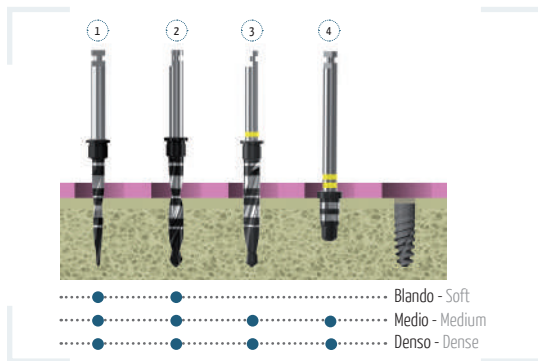

avantgard PEAK Ø3,30			
Descripción - Description		Ref.	
1	Fresa inicial	Initial drill	KYFOC1401
2	Fresa piloto Ø2,50 mm	Pilot drill Ø2.50	KYFOC2250
3	Fresa escalonada Ø2,50/Ø2,80 mm	Step drill Ø2.50/Ø2.80 mm	KYFOC5129
4	Fresa cortical Ø3,20 mm	Cortical drill Ø3.20	KYFOC4333

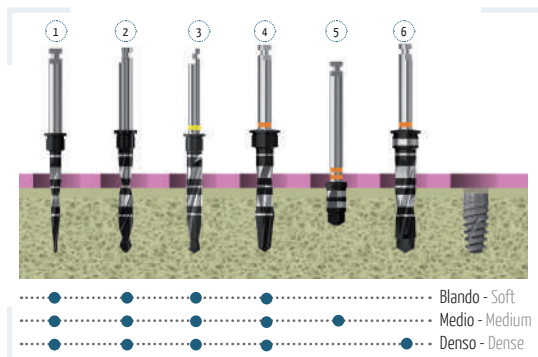

avantgard PEAK Ø3,75			
Descripción - Description		Ref.	
1	Fresa inicial	Initial drill	KYFOC1401
2	Fresa piloto Ø2,50 mm	Pilot drill Ø2.50	KYFOC2250
3	Fresa escalonada Ø2,50/Ø2,80 mm	Step drill Ø2.00/Ø2.80 mm	KYFOC5129
4	Fresa cónica Ø3,20 mm	Conical drill Ø3.20 mm	KYFOC7032
5	Fresa cortical Ø3,65 mm	Cortical drill Ø3.65	KYFOC4337
6	Fresa escalonada Ø3,20/Ø3,65 mm	Step drill Ø3.20/Ø3.65 mm	KYFOC5137

Secuencias fresado para implantes gmi® avantgard PEAK - Drilling sequences for gmi® avantgard PEAK implants

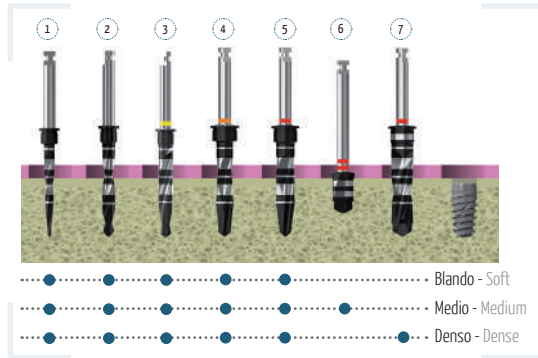

avantgard PEAK Ø4,25		
Descripción - Description		Ref.
1	Fresa inicial Initial drill	KYFOC1401
2	Fresa piloto Ø2,50 mm Pilot drill Ø2.50	KYFOC2250
3	Fresa escalonada Ø2,50/Ø2,80 mm Step drill Ø2.00/Ø2.80 mm	KYFOC5129
4	Fresa cónica Ø3,20 mm Conical drill Ø3.20 mm	KYFOC7032
5	Fresa cónica Ø3,70 mm Conical drill Ø3.70 mm	KYFOC7037
6	Fresa cortical Ø4,15 mm Cortical drill Ø4.15 mm	KYFOC4342
7	Fresa escalonada Ø3,70/Ø4,15 mm Step drill Ø3.70/Ø4.15 mm	KYFOC5142

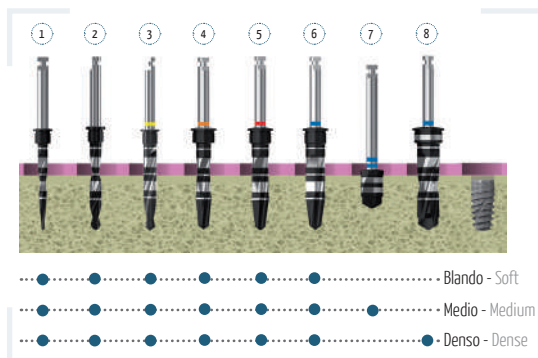

avantgard PEAK Ø4,75		
Descripción - Description		Ref.
1	Fresa inicial Initial drill	KYFOC1401
2	Fresa piloto Ø2,50 mm Pilot drill Ø2.50	KYFOC2250
3	Fresa escalonada Ø2,50/Ø2,80 mm Step drill Ø2.00/Ø2.80 mm	KYFOC5129
4	Fresa cónica Ø3,20 mm Conical drill Ø3.20 mm	KYFOC7032
5	Fresa cónica Ø3,70 mm Conical drill Ø3.70 mm	KYFOC7037
6	Fresa cónica Ø4,20 mm Conical drill Ø4.20 mm	KYFOC7042
7	Fresa cortical Ø4,65 mm Cortical drill Ø4.65 mm	KYFOC4347
8	Fresa escalonada Ø4,15/Ø4,65 mm Step drill Ø4.15/Ø4.65 mm	KYFOC5147

* El proceso recomendado por GMI® no puede sustituir el criterio y la experiencia del cirujano. - * Procedure recommended by GMI® cannot replace the judgment and the experience of the surgeon.

Pilares de cicatrización gmi® avantgard - gmi® avantgard healing abutments

Una vez finalizada la fase de reparación de los tejidos de sostén del implante, en el caso de implantes cubiertos total o parcialmente por tejido blando, debe existir un canal o túnel mucoso que permita la conexión del implante a la estructura secundaria o prótesis. Los pilares de cicatrización son los encargados de formar esta vía mucosa una vez se ha abierto por incisión el tejido blando, se ha retirado el tapón de cierre y han sido roscados al implante.

Once the repair phase of the tissue supporting the implant has finished, in the case of implants fully or partially covered by soft tissue there must be a mucosal channel or tunnel enabling connection of the implant to the prosthesis or secondary structure. Healing abutments are used to form the mucosal route, once the soft tissue has been opened by incision and the cover screw has been withdrawn, by screwing them to the implant.

Características principales

- Mecanizados en titanio grado V según norma ISO-5832.
- Apriete con llave hexagonal de e/c 1,20 mm.
- Disponibles en alturas de emergencia de 1,50 a 4,50 mm.
- Mecha apical para facilitar el inicio de roscado.
- Par apriete manual: Máx. 15 N-cm.

Key features

- Grade V titanium machining as per ISO-5832 standard.
- Tightening with b/f 1.20 mm hex wrench.
- Available in emergency heights from 1.50 to 4.50 mm.
- Apical bit to facilitate the start of threading.
- Manual tightening torque: Max. 15 N-cm.



Plataforma Platform	Ø cabeza Ø head	Altura (mm) Height (mm)	Ref.
NP ●●	Ø 4,00	1,50	KDPoC4012
		2,50	KDPoC4013
		3,50	KDPoC4014
		4,50	KDPoC4015
RP ●●	Ø 5,00	1,50	KDPoC4016
		2,50	KDPoC4017
		3,50	KDPoC4018
		4,50	KDPoC4019



Plataforma Platform	Ø cabeza Ø head	Altura (mm) Height (mm)	Ref.
NP ●●	Ø 5,00	1,50	KDPoC4001
		2,50	KDPoC4002
		3,50	KDPoC4003
		4,50	KDPoC4004
RP ●●	Ø 6,00	2,50	KDPoC4009
		3,50	KDPoC4010
		4,50	KDPoC4011

Pilares de cicatrización gmi® avantgard - gmi® avantgard healing abutments



Plataforma Platform	Ø cabeza Ø head	Altura (mm) Height (mm)	Ref.
WP ●	Ø 6,00	1,50	KDPoC4005
		2,50	KDPoC4006
		3,50	KDPoC4007
		4,50	KDPoC4008

Pilares transportador gmi® avantgard - gmi® avantgard implant carrier abutments

Cuando sea necesario utilizar un pilar a medida se utilizarán los pilares transportador, que permitirán, mediante el corte en cualquier dirección, adecuarse a las necesidades del protésico. Además y como función complementaria, los pilares transportador pueden ser utilizados como toma de impresión de cubeta cerrada.

When the use of a custom abutment is required, implant carrier abutments can be used. By cutting them in any direction, they can be suited to the needs of the prosthetic. In addition and as a complementary function, implant carrier abutments can be used like closed tray impression coping.

Características principales

- Mecanizados en titanio grado V según norma ISO-5832.
- Permiten corte en cualquier dirección adecuándose a las necesidades protésicas.
- Compatibles con llave hexagonal de e/c 3,00 mm para utilizar como transportador.
- Disponibles sólo en versión anti-rotatoria.
- Posibilidad de utilizarlos como toma de impresión.
- Incluye tornillo clínica premontado.
- Par apriete tornillo: 25 N-cm.

Key features

- Grade V titanium machining as per ISO-5832 standard.
- They allow cutting in any direction to suit the needs of the prosthetic.
- Compatible with b/f 3.00 mm hex wrench for use as an implant carrier.
- Available only in non-rotary version.
- Possibility to use as impression coping.
- Premounted clinic screw included.
- Screw tightening torque: 25 N-cm.

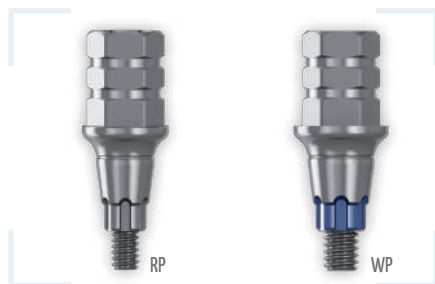

Plataforma Platform	Ø hombro Ø shoulder	Ref.
RP ●●	Ø 3,75 - Ø 4,25	KDBoF4001
WP ●	Ø 4,75	KDBoF4002
	Ø 5,75	KDBoF4003

Pilares provisionales gmi® avantgard - gmi® avantgard temporary abutments

Cuando es necesario efectuar una restauración mientras se consolida la interfase hueso-implante se utilizan los pilares provisionales, que se definen como los aditamentos que, una vez fijados a la parte coronal del implante mediante el tornillo clínica, permitirán efectuar una restauración temporal mientras se fabrica la restauración definitiva.

Características principales

- Mecanizado en plástico técnico de alta resiliencia.
- Los pilares NP están mecanizados en titanio grado V según norma ISO-5832.
- Versión rotatoria únicamente para restauraciones múltiples.
- Plano anti-rotatorio y regatas transversales para facilitar la retención.
- Tornillo clínica incluido.
- Par apriete manual: Máx. 15 N·cm.

When it is necessary to perform a provisional restoration while the bone-implant interfaces or the soft tissues are healing, the temporary abutment is used, defined as attachment that once attached to the crown of the implant with clinic screw, they will allow a temporary restoration to be carried out while the definitive restoration is being manufactured.

Key features

- Machined in high strength technical plastic.
- NP abutments machined in Grade V titanium as per ISO-5832 standard
- Rotary version only for multiple restorations.
- Anti-rotational plane and transverse retention to provide good fixation.
- Clinic screw included.
- Manual tightening torque: Max. 15 N·cm.

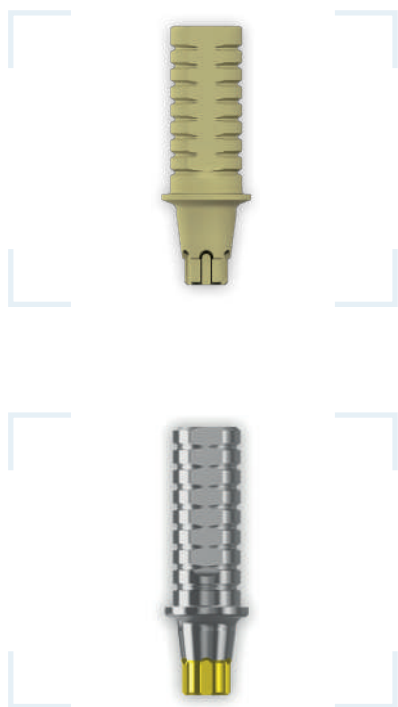

Plataforma Platform	Tipo conexión Connection type	Ref.
RP ● ●	Anti-rotatoria • Non-rotary	KDHOF4001
	Rotatoria • Rotary	KDHOF4002
WP ●	Anti-rotatoria • Non-rotary	KDHOF4003
	Rotatoria • Rotary	KDHOF4004

Plataforma Platform	Altura (mm) Height (mm)	Tipo conexión Connection type	Ref.
NP ● ●	1,50	Anti-rotatoria • Non-rotary	KDHOF4009
	3,00	Anti-rotatoria • Non-rotary	KDHOF4010
	1,50	Rotatoria • Rotary	KDHOF4011
	3,00	Rotatoria • Rotary	KDHOF4012

Pilares inclinados gmi® avantgard - gmi® avantgard angled abutments

Cuando es necesario corregir una posición angular extrema del implante en el interior de la estructura ósea, en relación a las piezas naturales o implantes adyacentes, se utilizarán los pilares inclinados que, una vez montados y orientados sobre el implante, permitirán la paralelización de la nueva corona con el resto de estructuras.

Características principales

- Mecanizados en titanio grado V según norma ISO-5832.
- Permiten corregir disparalelismos de hasta 20 grados.
- Incluye tornillo clínica.
- Hombro del pilar adaptado a la forma de la encía.
- Par apriete tornillo: 25 N-cm.

When it is necessary to correct an extreme angular position of the implant inside the bone structure in relation to adjacent natural or prosthetic teeth, angled abutments should be used. Once mounted and oriented on the implant, these abutments will allow the parallelization of the new crown with other structures.

Key features

- Grade V titanium machining as per ISO-5832 standard.
- Allow non-parallelism correction up to 20 degrees.
- Clinic screw included.
- Abutment shoulder adapted to the shape of the gum.
- Screw tightening torque: 25 N-cm.

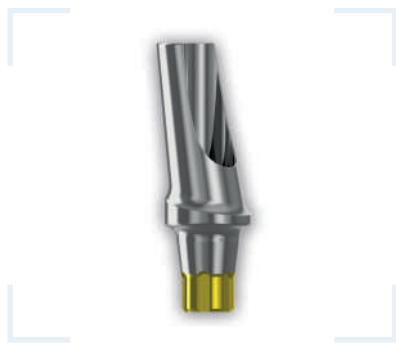

Plataforma Platform	Ang. (°)	Altura (mm) Height (mm)	Ref.
NP ●●	10°	2,50	KDMoF4039
	10°	4,50	KDMoF4040
	20°	2,50	KDMoF4041
	20°	4,50	KDMoF4042

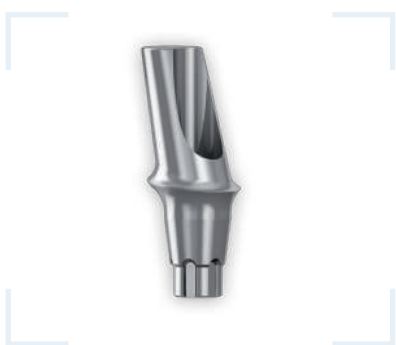

Plataforma Platform	Ang. (°)	Altura (mm) Height (mm)	Ref.
RP ●●	15°	2,50	KDMoF4013
	15°	4,50	KDMoF4014
	20°	2,50	KDMoF4015
	20°	4,50	KDMoF4016

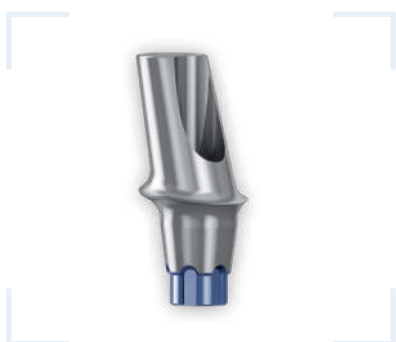

Plataforma Platform	Ang. (°)	Altura (mm) Height (mm)	Ref.
WP ●	15°	2,50	KDMoF4017
	15°	4,50	KDMoF4018
	20°	2,50	KDMoF4019
	20°	4,50	KDMoF4020

Pilares rectos gmi® avantgard - gmi® avantgard straight abutments

Una vez formado el túnel mucoso por el pilar de cicatrización y retirado este de su localización, se procede a utilizar el pilar correspondiente, que se define como el aditamento mecanizado cónico que una vez fijado con el tornillo clínica a la parte superior del implante sirve de soporte para la corona clínica fijándose a ésta mediante la utilización de cemento.

Características principales

- Mecanizados en titanio grado V según norma ISO-5832.
- Planos anti-rotatorios para facilitar la retención.
- Disponibles sólo en versión anti-rotatoria.
- Tornillo clínica incluido.
- Disponibles en cuatro alturas de emergencia de 1,50 a 4,50 mm.
- Par apriete tornillo: 25 N-cm.

Once the mucosal tunnel has been formed by the healing abutment and after removing it from this location, it is appropriate to use the abutment, which is defined as the machined tapered attachment that, after being fixed with the clinic screw to the top of the implant, acts as a support for the clinic crown and is attached to it using cement.

Key features

- Grade V titanium machining as per ISO-5832 standard.
- Anti-rotational planes to increase retention.
- Available only in non-rotary version.
- Clinic screw included.
- Available in four emergency heights from 1.50 to 4.50 mm.
- Screw tightening torque: 25 N-cm.



Plataforma Platform	Ø hombro Ø shoulder	Altura (mm) Height (mm)	Ref.
NP ●●	Ø 4,00	1,50	KDMoF4035
		2,50	KDMoF4036
		3,50	KDMoF4037
		4,50	KDMoF4038



Plataforma Platform	Ø hombro Ø shoulder	Altura (mm) Height (mm)	Ref.
RP ●●	Ø 4,00	1,50	KDMoF4001
		2,50	KDMoF4002
		3,50	KDMoF4003
		4,50	KDMoF4004
	Ø 5,00	1,50	KDMoF4005
		2,50	KDMoF4006
		3,50	KDMoF4007
		4,50	KDMoF4008

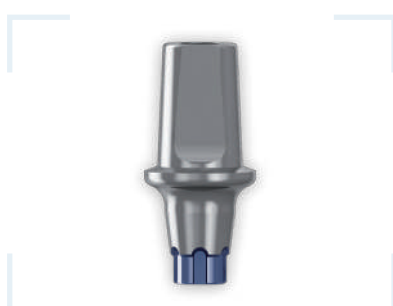

Plataforma Platform	Ø hombro Ø shoulder	Altura (mm) Height (mm)	Ref.
WP ●	Ø 6,00	1,50	KDMoF4009
		2,50	KDMoF4010
		3,50	KDMoF4011
		4,50	KDMoF4012

Base titanio gmi® avantgard - gmi® avantgard titanium base

Una vez formado el túnel mucoso por el pilar de cicatrización y retirado este de su localización, se procede a utilizar la base de titanio correspondiente, que se define como el aditamento mecanizado cónico que una vez fijado con el tornillo clínica a la parte superior del implante sirve de soporte para una meso-estructura metálica o cerámica ya sea colada o mecanizada mediante CAD/CAM.

Características principales

- Mecanizados en titanio grado V según norma ISO-5832.
- Versión anti-rotatoria y rotatoria.
- Tornillo clínica incluido.
- Disponible en altura de emergencia de 1,50 mm y de 3,00 mm.
- Elemento anti-giro en base anti-rotatoria que permite indexación.
- Par apriete tornillo: 25 N-cm.
- Escaneo directo sobre la Base de titanio o escaneo alternativo sobre el Pilar escaneado.

Once the mucosal tunnel has been formed by the healing abutment and after removing the cap from this location, it is appropriate to use the titanium base, which is defined as the machined tapered attachment that, after being fixed with the clinic screw to the top of the implant, acts as a support for a metallic or ceramic meso-structure casted or machined with CAD/CAM.

Key features

- Grade V titanium machining as per ISO-5832 standard.
- Non-rotary and rotary version.
- Clinic screw included.
- Available in emergency height of 1.50 mm and 3.00 mm.
- Non-rotary titanium base with indexation.
- Screw tightening torque: 25 N-cm.
- Scan directly on Titanium base or alternative scan on Scan abutment.



Base titanio - Titanium base

Plataforma Platform	Altura (mm) Height (mm)	Tipo conexión Connection type	Ref.
NP ●●	1,50	Anti-rotatoria - Non-rotary	KDMoF4043
	1,50	Rotatoria - Rotary	KDMoF4045
	3,00	Anti-rotatoria - Non-rotary	KDMoF4044
	3,00	Rotatoria - Rotary	KDMoF4046
RP ●●	1,50	Anti-rotatoria - Non-rotary	KDMoF4021
	1,50	Rotatoria - Rotary	KDMoF4023
	3,00	Anti-rotatoria - Non-rotary	KDMoF4025
	3,00	Rotatoria - Rotary	KDMoF4027
WP ●	1,50	Anti-rotatoria - Non-rotary	KDMoF4022
	1,50	Rotatoria - Rotary	KDMoF4024
	3,00	Anti-rotatoria - Non-rotary	KDMoF4026
	3,00	Rotatoria - Rotary	KDMoF4028

Base titanio gmi® avantgard - gmi® avantgard titanium base



Calcinable - Castable		
Plataforma Platform	Altura total (mm) Total Height (mm)	Ref.
NP - RP ● ●	11,00	KDCoC3605
WP ●	11,00	KDCoC3606

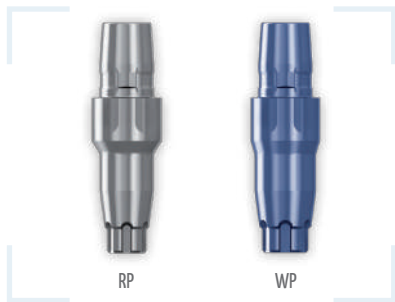

Pilar escaneado - Scan abutment		
Plataforma Platform	Altura (mm) Height (mm)	Ref.
RP ● ●	6,30	KDioF4001
WP ●	6,30	KDioF4002



Cuerpo pilar escaneado - Scanbody		
Plataforma Platform	Altura (mm) Height (mm)	Ref.
NP - RP - WP ● ●	7,50	KDioC4003

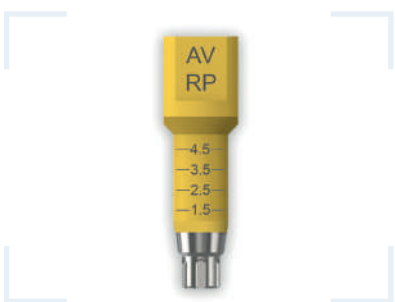

Scanbody de titanio - Titanium scanbody		
Plataforma Platform	Altura (mm) Height (mm)	Ref.
NP ● ●	12,30	KDioF4006
RP ● ●	12,30	KDioF4004
WP ●	12,30	KDioF4005

Pilares multi-estético gmi® avantgard - gmi® avantgard multi-esthetic abutments

Una vez efectuada la primera etapa de la cirugía, y por tanto obtenida la osteointegración del implante, se procede a utilizar el pilar multi-estético (PME), que se define como el aditamento mecanizado que una vez fijado a la parte coronal del implante sirve como soporte de una restauración múltiple, disminuyendo la altura entre la conexión del implante y la conexión de la estructura, y facilitando el ajuste pasivo de la estructura.

Características principales

- Mecanizados en titanio grado V según norma ISO-5832.
- Disponibles en alturas de emergencia de 1,50 a 4,50 mm.
- Pilares rectos de una sola pieza en versión rotatoria.
- Apriete con llave hexagonal: E/C 2,00 mm (KYLOCO149).
- Toma de impresión con tornillo incluido.
- Calcinable con tornillo clínica incluido.
- Cilindro provisional en titanio grado V según ISO-5832, con tornillo clínica incluido.
- Los PME inclinados permiten corregir disparalelismos de hasta 30 grados.
- Pares apriete: PME recto (30 N-cm), PME inclinado (20 N-cm) y Pilar cicatrización (Manual: Máx. 15 N-cm).

Following the first stage of surgery and therefore after implant osseointegration is achieved, the multi-esthetic abutment (MEA) is used, that is defined as the machined attachment that, after being attached to the crown of the implant, serves as a support for a multiple restoration, thus decreasing the height between the implant connection and the structure connection, and providing a passive adjustment of the structure.

Key features

- Grade V titanium machining as per ISO-5832 standard.
- Available in emergency heights from 1.50 to 4.50 mm.
- One-piece straight abutments in rotary version.
- Tightened with hex wrench: B/F 2.00 mm (KYLOCO149).
- Impression coping with screw included.
- Castable with clinic screw included.
- Temporary cylinder in grade V titanium with clinic screw included.
- Angled multi-esthetic abutments allow non-parallelism up to 30°.
- Tightening torques: ME straight abut. (30 N-cm), ME angled abut. (20 N-cm) and healing caps (Manual: Max. 15 N-cm).



Pilares multi-estético rectos Multi-esthetic straight abutments

Plataforma Platform	Altura (mm) Height (mm)	Ref.
NP ●●	1,50	KDGoF4019
	2,50	KDGoF4020
	3,50	KDGoF4021
	4,50	KDGoF4022
RP ●●	1,50	KDGoF4001
	2,50	KDGoF4002
	3,50	KDGoF4003
	4,50	KDGoF4004
WP ●	1,50	KDGoF4005
	2,50	KDGoF4006
	3,50	KDGoF4007
	4,50	KDGoF4008

Pilares multi-estético gmi® avantgard - gmi® avantgard multi-esthetic abutments



Pilares multi-estético inclinados Multi-esthetic angled abutments			
Plataforma Platform	Ang. (°)	Altura (mm) Height (mm)	Ref.
	17°	2,50	KDGoF4009
RP ●●	17°	3,50	KDGoF4010
	30°	4,00	KDGoF4011



Pilares cicatrización PME Healing abutments MEA		
Plataforma Platform	Ø Diámetro (mm) Ø Diameter (mm)	Ref.
NP - RP - WP ●●	Ø 4,80	KDPoF0035
	Ø 6,00	KDPoF0037



Tomas impresión cubeta abierta (CA) larga PME Open tray (OT) long impression coping MEA	
Plataforma Platform	Ref.
NP - RP - WP ●●	KDSoF0015

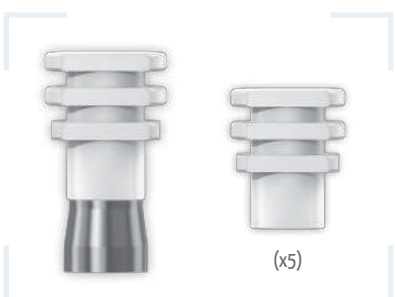

Tomas impresión cubeta cerrada (CC) PME Closed tray (CT) impression coping MEA		
Plataforma Platform	Cantidad (Ud.) Quantity (Un.)	Ref.
	1	KDSoF0017
NP - RP - WP ●●	5	KDSoF5001

Pilares multi-estético gmi® avantgard - gmi® avantgard multi-esthetic abutments



Cilindro provisional PME
Temporary cylinder MEA

Plataforma
Platform

Ref.

NP - RP - WP ● ●

KDG0F0028



Calcinable PME
Castable MEA

Plataforma
Platform

Ref.

NP - RP - WP ● ●

KDC0F0117



Base titanio PME
Titanium base MEA

Plataforma
Platform

Ref.

NP - RP - WP ● ●

KDG0F0035



Scanbody de titanio PME
Titanium scanbody MEA

Plataforma
Platform

Ref.

NP - RP - WP ● ●

KDIOF0002

Bases bioestéticas gmi® avantgard - gmi® avantgard bioesthetic bases

Una vez finalizada la inserción del implante en el lecho óseo se procede a utilizar la base bioestética que se define como el aditamento mecanizado que una vez fijada a la parte coronal del implante permite efectuar restauraciones unitarias a nivel del pilar.

La colocación de la base bioestética durante la cirugía permite que los tejidos blandos cicatricen alrededor de ésta.

Una vez cicatrizado el tejido, sirve como base para efectuar la rehabilitación evitando la conexión y desconexión de los componentes al implante y, por tanto, manteniendo intacto el sellado biológico.

Características principales

- Mecanizados en titanio grado V según norma ISO-5832.
- Disponibles en alturas de emergencia de 2,50 a 4,50 mm.
- Bases rectas de dos piezas, incluyendo el tornillo.
- Apriete con llave hexagonal: E/C 2,00 mm (KYLOCo149).
- Toma de impresión con tornillo incluido.
- Calcinable.
- Pares apriete: Base BE (25 N-cm) y pilar cicatrización (Manual: Máx. 15 N-cm).

Once the insertion of the implant in the bone bed has been completed, the bioesthetic base is used, which is defined as the machined attachment that, once fixed to the coronal part of the implant, allows single restorations at the abutment level.

Placing the bioesthetic base during surgery allows the soft tissues to heal around it.

Once the tissue has healed, it serves as the basis for the rehabilitation, avoiding the connection and disconnection of the components to the implant and, therefore, keeping the biological seal intact.

Key features

- Grade V titanium machining as per ISO-5832 standard.
- Available in emergency heights from 2.50 to 4.50 mm.
- Straight two-piece bases, including the screw.
- Tightened with hex wrench: B/F 2.00 mm (KYLOCo149).
- Impression coping with screw included.
- Castable.
- Tightening torques: BE base (25 N-cm) and healing abutment (Manual: Max. 15 N-cm).



Bases bioestéticas Bioesthetic bases		
Plataforma Platform	Altura (mm) Height (mm)	Ref.
RP ●●	2,50	KDGoF4012
	3,50	KDGoF4013
	4,50	KDGoF4014
WP ●	2,50	KDGoF4015
	3,50	KDGoF4016
	4,50	KDGoF4017



Pilar cicatrización BE BE healing abutment		
Plataforma Platform	Ø Diámetro (mm) Ø Diameter (mm)	Ref.
RP - WP ●●	Ø 4,80	KDPOCo038

Bases bioestéticas gmi® avantgard - gmi® avantgard bioesthetic bases



Toma impresión cubeta abierta (CA) BE
BE open tray (OT) impression coping

Plataforma
Platform

Ref.

RP - WP ●●

KDS0F0018

Calcinable BE
BE castable

Plataforma
Platform

Ref.

RP - WP ●●

KDC0C0019

Base de titanio BE
BE titanium base

Plataforma
Platform

Ref.

RP - WP ●●

KDGoF4018

Scanbody de titanio BE
BE titanium scanbody

Plataforma
Platform

Ref.

RP - WP ●●

KDIOF0004

Bloques pre-fresados CrCo gmi® avantgard - gmi® avantgard CrCo pre-milled blanks

Los bloques pre-fresados de CrCo constan de un bloque de CrCo con la conexión del implante mecanizada, lo que permite mantener un excelente ajuste entre el implante y el pilar.

Están indicados para producir pilares personalizados de una sola pieza mediante CAD/CAM permitiendo la aplicación directa de la cerámica.

CrCo pre-milled blanks consist of a block with the implant connection machined, which allows an excellent fit between the implant and the abutment.

They are indicated to produce custom one-piece abutments using CAD/CAM allowing direct application of ceramic.

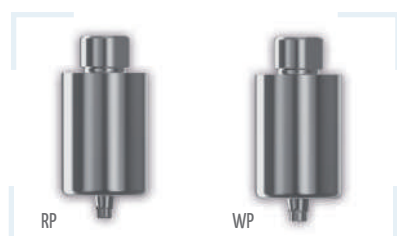

Plataforma
Platform

Ref.

RP ●●

TS00005

WP ●

TS00006

Réplicas gmi® avantgard - gmi® avantgard replicas

Una vez realizada la transferencia de la posición mediante la toma de impresión del medio biológico al modelo de trabajo de laboratorio, es necesario utilizar las réplicas, que se definen como el aditamento mecanizado destinado por una parte a reproducir la posición del implante en la boca del paciente a un modelo de trabajo y por otra a servir de modelo de conexión para la construcción en el laboratorio de la estructura destinada a efectuar la restauración.

Características principales

- Mecanizados en titanio grado V según norma ISO-5832.
- Fresados anti-giro y cuello de retención vertical para una buena fijación.

Once the transfer of the position has been made using the impression coping from the biological medium to the laboratory working model, it is necessary to use replicas, which are defined as the machined attachments designed on one hand to reproduce the implant position in the mouth of the patient to a working model, and on the other to serve as a connection model for the construction in the laboratory of the structure to carry out the restoration.

Key features

- Grade V titanium machining as per ISO-5832 standard.
- Anti-rotation millings and vertical retention neck for a good fixation.



Réplicas de implante Implant replicas	
Plataforma Platform	Ref.
NP ●●	KDRoC4005
RP ●●	KDRoC4001
WP ●	KDRoC4002

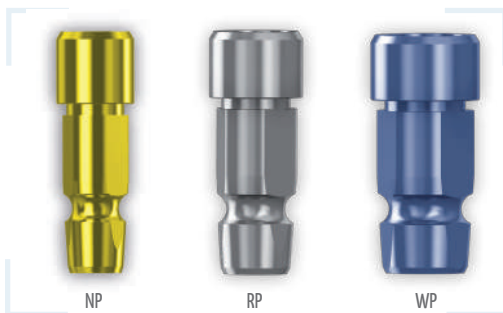

Réplicas digitales Digital replicas	
Plataforma Platform	Ref.
NP ●●	KDRoF4006
RP ●●	KDRoF4003
WP ●	KDRoF4004



Réplicas para pilares multi-estético MEA replicas	
Plataforma Platform	Ref.
NP - RP - WP ●●	KDRoC0012



Réplicas digitales para pilares multi-estético MEA digital replicas	
Plataforma Platform	Ref.
NP - RP - WP ●●	KDRoF0014

Rélicas gmi® avantgard - gmi® avantgard replicas



Réplica digital BE BE digital replica		
Plataforma Platform		Ref.
RP - WP ●●		KDRoF0016

Tomas de impresión gmi® avantgard - gmi® avantgard impression coping

Las tomas de impresión se definen como el aditamento mecanizado que conexasiónado a la parte coronal del implante en el interior de la cavidad bucal, y fijado axialmente mediante el tornillo de impresión, sirve para realizar la transferencia de la posición del implante en el medio biológico a un modelo de laboratorio, sobre el cual trabajará el protésico para crear las coronas o prótesis dentales. Este proceso se consigue utilizando materiales de impresión que colocados de forma apropiada, se endurecen en la cavidad bucal permitiendo la obtención del negativo de la boca del paciente. Una vez extraído, se colocan las réplicas y se efectúa el vaciado de escayola para obtener el molde positivo donde la réplica quedará en la posición original del implante en boca.

Características principales

- Toma impresión CA mecanizada en titanio grado V según norma ISO-5832.
- Tornillos de impresión mecanizados en titanio grado V según norma ISO-5832.
- Apriete tornillos impresión con llave hexagonal de e/c 1,20 mm.
- Mecha apical para facilitar el inicio de roscado del tornillo impresión.
- Fresados anti-giro y cuello de retención vertical para una buena fijación.
- Tornillos de toma de impresión incluidos.
- Tornillo largo con fresados longitudinales para apriete manual.
- Toma de impresión CC mecanizada en plástico técnico.
- Par apriete manual: Máx. 15 N-cm.

Impression coping are defined as the machined attachments that, connecting to the coronal part of the implant within the oral cavity and axially fixed by the impression screw, is used to make the transfer of the position of the implant in the biological medium to a laboratory model, on which the prosthetic will work to create the dental crowns or prostheses. This process is achieved using impression materials placed in an appropriate manner, that will harden in the oral cavity and produce the negative of the patient's mouth. Once extracted, replicas are placed and the casting plaster is poured to obtain the positive mould where the replica will be placed in the original position of the implant in the mouth.

Key features

- Machined open tray impression coping in grade V titanium according to ISO-5832.
- Impression screws in grade V titanium according to ISO-5832.
- Tightening of impression screws with b/f 1.20 mm hex wrench.
- Apical bit to facilitate the start of threading impression screw.
- Anti-rotation millings and vertical retention neck for a good fixation.
- Impression coping screw included.
- Long impression screw with longitudinal millings for manual tightening.
- CT impression coping machined in technical plastic.
- Manual tightening torque: Max. 15 N-cm.

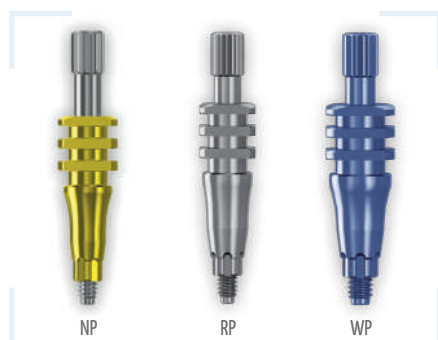

Tomas impresión cubeta abierta (CA) Open tray (OT) impression coping		
Plataforma Platform	Tornillo Screw	Ref.
NP ●●	Largo • Long	KDS0F4005
RP ●●	Largo • Long	KDS0F4001
	Corto • Short	KDS0F4003
WP ●	Largo • Long	KDS0F4002
	Corto • Short	KDS0F4004

Tomas de impresión gmi® avantgard - gmi® avantgard impression coping

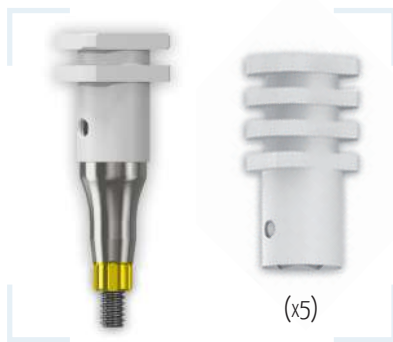

Tomas impresión cubeta cerrada (CC) plástico transportador Closed tray (CT) plastic impression coping implant-carrier

Plataforma Platform	Ref.
NP ●●	KDSOF4007 KDSOF0019 (x5)
RP - WP ●●	KDSOF0014 (x5)

Tornillos clínica y laboratorio gmi® avantgard - gmi® avantgard clinic and laboratory screws

Los tornillos clínica se definen como los aditamentos mecanizados utilizados para el anclaje definitivo de los pilares o del calcinable directo al implante, mientras que los tornillos de laboratorio son los aditamentos mecanizados utilizados para el anclaje provisional de los pilares a la réplica del implante, utilizados por el protésico en el laboratorio donde se construyen las coronas dentales o prótesis.

Clinic screws are defined as machined devices used for the final anchoring of the abutments or the castable directly to the implant, while laboratory screws are the machined devices used for the temporary anchoring of abutments to the replica of the implant used by the dental laboratory where the construction of dental crowns or prostheses takes place.

Características principales

- Tornillos mecanizados en titanio grado V según norma ISO-5832.
- Apriete tornillos con llave hexagonal de e/c 1,20 mm.
- Tornillo TX permite angular el canal del tornillo hasta 20°.

Key features

- Machined grade V titanium screws according to ISO-5832.
- Tightening of screws with b/f 1.20 mm hex wrench.
- TX screw allows the screw channel to be angled up to 20°.

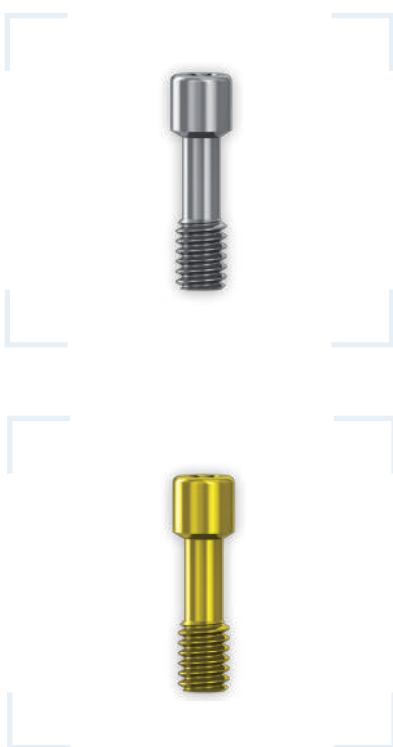

Tornillo clínica Clinic screw		
Plataforma Platform	Hex. llave (mm) Hex. wrench (mm)	Ref.
NP - RP ●●	⊕ 1,20 mm	KDToC4003
	⊕ TX	KDToC4021
WP ●	⊕ 1,20 mm	KDToC4004
	⊕ TX	KDToC4022
Tornillo laboratorio Laboratory screw		
Plataforma Platform	Hex. llave (mm) Hex. wrench (mm)	Ref.
NP - RP ●●	⊕ 1,20 mm	KDToC4005
	⊕ TX	KDToC4023
WP ●	⊕ 1,20 mm	KDToC4006
	⊕ TX	KDToC4024

Tornillos PME y BE gmi® avantgard - gmi® avantgard MEA and BE screws

Los tornillos clínica para PME y BE se definen como los aditamentos mecanizados utilizados para el anclaje definitivo de los aditamentos ME y BE, mientras que los tornillos de laboratorio son los aditamentos mecanizados utilizados para el anclaje provisional de los aditamentos ME y BE a la réplica durante la elaboración de la prótesis en el laboratorio.

Características principales

- Tornillos mecanizados en titanio grado V según norma ISO-5832.
- Apriete tornillos con llave hexagonal de e/c 1,20 mm y 2,00 mm.
- Tornillo TX permite angular el canal del tornillo hasta 20°.

MEA and BE clinical screws are defined as machined devices used for the final anchoring of the ME and BE abutments, while laboratory screws are the machined devices used for the temporary anchoring of ME and BE abutments to the replica during the fabrication of the prostheses in the laboratory.

Key features

- Machined grade V titanium screws according to ISO-5832.
- Tightening of screws with b/f 1.20 mm and 2.00 mm hex wrench.
- TX screw allows the screw channel to be angled up to 20°.



Tornillo PME MEA screw		
Plataforma Platform	Hex. llave (mm) Hex. wrench (mm)	Ref.
NP - RP - WP ● ●	○ 1,20 mm	KDToC0056
	⊛ TX	KDToC0070



Tornillo laboratorio PME MEA laboratory screw		
Plataforma Platform	Hex. llave (mm) Hex. wrench (mm)	Ref.
NP - RP - WP ● ●	○ 1,20 mm	KDToC0057
	⊛ TX	KDToC0072



Tornillo BE BE screw		
Plataforma Platform	Hex. llave (mm) Hex. wrench (mm)	Ref.
RP - WP ● ●	○ 1,20 mm	KDToC4016
	⊛ TX	KDToC0074



Tornillo laboratorio BE BE laboratory screw		
Plataforma Platform	Hex. llave (mm) Hex. wrench (mm)	Ref.
RP - WP ● ●	○ 1,20 mm	KDToC4020
	⊛ TX	KDToC0075

Tornillos PME y BE gmi® avantgard - gmi® avantgard MEA and BE screws



Tornillo base BE BE base screw			
Plataforma Platform	Hex. llave (mm) Hex. wrench (mm)	Altura (mm) Height (mm)	Ref.
RP ●●	○ 2,00 mm	2,50	KDToC4013
		3,50	KDToC4014
		4,50	KDToC4015
WP ●	○ 2,00 mm	2,50	KDToC4017
		3,50	KDToC4018
		4,50	KDToC4019

Pares recomendados de apriete - Recommended tightening torques

Par máximo inserción implante • Implant insertion maximum torque

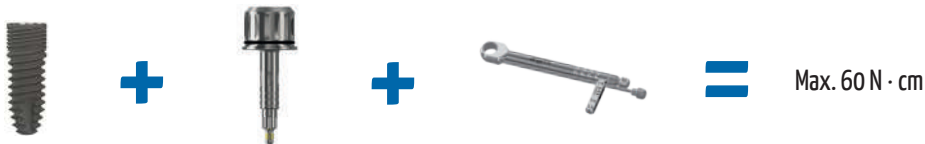

Apriete tapones de cierre y pilares de cicatrización • Healing abutments and cover screw tightening torque



Apriete tornillos clínica* • Clinic screw tightening torque*



Apriete pilares multi-estético rectos • Multi-esthetic straight abutments tightening torque



Apriete tornillos multi-estético* • Multi-esthetic screw tightening torque*



*Para los tornillos TX mismo par de apriete • *For TX screws same tightening torque

Pares recomendados de apriete - Recommended tightening torques

Apriete tornillo pilar provisional • Temporary cylinder screw tightening torque



Apriete tornillo pilar multi-estético inclinado • Multi-esthetic angled screw tightening torque

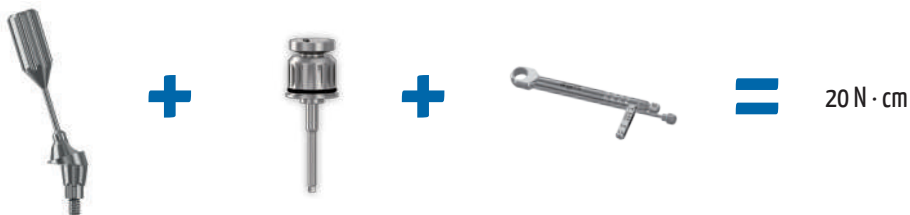

Apriete tornillo transportador • Implant carrier screw tightening torque



Apriete tornillo impresión • Impression coping screw tightening torque



Apriete bases bioestéticas • Bioesthetic bases tightening torque



Apriete pilar cicatrización bioestético • Bioesthetic healing abutment tightening torque



Apriete tornillo BE* • BE screw tightening torque*



*Para los tornillos TX mismo par de apriete • *For TX screws same tightening torque

Kit quirúrgico gmi® frontier/avantgard - gmi® frontier/avantgard surgical kit

El kit quirúrgico gmi® frontier/avantgard (Ref. KYCoF3053) está formado por una caja autoclavable fabricada en resina técnica de alta resistencia, que contiene todo el material necesario para la correcta colocación de los sistemas de implantes dentales frontier y avantgard. Los componentes se encuentran dispuestos de tal manera que sea sencillo encontrar en cada momento el instrumento necesario para cada fase de la intervención.

Los kits quirúrgicos gmi® se distribuyen en cajas confeccionadas en polímero técnico de alta resistencia y deben esterilizarse en autoclave de calor húmedo antes de su uso a una temperatura máxima de 134°C.

Para complementar este kit gmi® dispone del Kit de fresas PEAK (Ref. KYCoF3056 - *ver catálogo de instrumental*), permitiendo ampliar de forma fácil y práctica su uso para la colocación de 2 sistemas de implantes adicionales (frontier PEAK y avantgard PEAK).

gmi® frontier/avantgard (Ref. KYCoF3053) surgical kit consists of an autoclavable case made of high strength resin, containing all the necessary material for the correct positioning of gmi frontier and avantgard dental implant systems. The components are arranged in such a way to be easy to find in each moment and in any stage of the intervention.

gmi® surgical kits are distributed in boxes made of high strength technical polymer, and must be sterilized in a moist heat autoclave before use at a maximum temperature of 134°C.

To complement this kit, gmi® has the PEAK drill Kit (Ref. KYCoF3056 - *see instrumental catalogue*), allowing it to be easily expanded for the placement of 2 additional implant systems (frontier PEAK and avantgard PEAK).



KYCoF3053



KYCoF3059

Ref. KYCoF3059 - Kit para el sistema gmi® avantgard únicamente, sin la fresa y las llaves exclusivas del sistema frontier (*ver tabla, resaltado en rojo*).

Ref. KYCoF3059 - Kit for gmi® avantgard system only, without the drill and the wrenches exclusive to the frontier system (*see table, highlighted in red*).

Descripción - Description		Un.	Ref.
Fresa lanza	Lance-shaped drill	1	KYFoC1225
Fresa piloto ø2,50 mm	Pilot drill ø2.50 mm	1	KYFoC2250
Fresa escalonada ø2,50 / ø3,00 mm	Step drill ø2.50 / ø3.00 mm	1	KYFoC5130
Fresa escalonada ø3,00 / ø3,50 mm	Step drill ø3.00 / ø3.50 mm	1	KYFoC5135
Fresa escalonada ø3,50 / ø4,00 mm	Step drill ø3.50 / ø4.00 mm	1	KYFoC5140
Fresa escalonada ø4,00 / ø4,50 mm	Step drill ø4.00 / ø4.50 mm	1	KYFoC5145
Fresa cortical ø3,65 mm	Cortical drill ø3.65 mm	1	KYFoC4336
Fresa cortical ø3,20 mm	Cortical drill ø3.20 mm	1	KYFoC4332
Fresa cortical ø4,00 mm	Cortical drill ø4.00 mm	1	KYFoC4340
Fresa cortical ø4,50 mm	Cortical drill ø4.50 mm	1	KYFoC4345
Fresa cortical ø4,90 mm	Cortical drill ø4.90 mm	1	KYFoC4349
Fresa cortical ø5,90 mm	Cortical drill ø5.90 mm	1	KYFoC4359
Llave carraca IP	TI ratchet wrench	1	KYLoF0113
Llave-transportador HEX-2,45 mm IP corta	Short HEX-2.45 mm implant carrier TI wrench	1	KYLoF0096
Llave-transportador HEX-2,45 mm IP larga	Long HEX-2.45 mm implant carrier TI wrench	1	KYLoF0111
Llave-transportador HEX-2,45 mm CA	HEX-2.45 mm implant carrier HP wrench	1	KYLoF0091
Llave Avantgard NP/RP IP corta	Short Avantgard NP/RP TI wrench	1	KYLoF0157
Llave Avantgard NP/RP IP larga	Long Avantgard NP/RP TI wrench	1	KYLoF0162
Llave Avantgard WP IP corta	Short Avantgard WP TI wrench	1	KYLoF0168
Llave Avantgard WP IP larga	Long Avantgard WP TI wrench	1	KYLoF0169
Llave Avantgard NP/RP CA corta	Short Avantgard NP/RP HP wrench	1	KYLoF0151
Llave Avantgard WP CA corta	Short Avantgard WP HP wrench	1	KYLoF0166
Llave carraca corta HEX-1,20 mm	Short HEX-1.20 mm ratchet wrench	1	KYLoF0128
Llave carraca larga HEX-1,20 mm	Long HEX-1.20 mm ratchet wrench	1	KYLoF0129
Alargador fresas	Drill extender	1	KYLoC0023
Paralelizador ø2,00 / ø2,80 mm	Paralleling pin ø2.00 / ø2.80 mm	3	KYLoC0078
Indicador profundidad ø2,50 mm	Depth gauge ø2.50 mm	1	KYLoC0165

Kit cirugía guiada gmi® avantgard - gmi® avantgard guided surgery kit

El kit de cirugía guiada gmi® avantgard (Ref. KYCoF3049) está formado por una caja autoclavable fabricada en resina técnica de alta resistencia, que contiene todo el material necesario para efectuar cirugías totalmente guiadas de implantes gmi® avantgard de $\varnothing 3,30$ / $\varnothing 3,75$ / $\varnothing 4,25$ y $\varnothing 4,75$ mm y longitudes comprendidas entre 8 y 13 mm.

Para complementar este kit gmi® dispone del Kit de fresas de cirugía guiada PEAK (Ref. KYCoF3052 - ver catálogo de instrumental), permitiendo ampliar de forma fácil y práctica su uso para la colocación de 1 sistema de implantes adicional (avantgard PEAK).

gmi® avantgard guided surgery kit (Ref. KYCoF3049) consists of an autoclavable case made of high strength resin, containing all the necessary material for performing totally guided surgeries with gmi® avantgard implants of $\varnothing 3.30$ / $\varnothing 3.75$ / $\varnothing 4.25$ and $\varnothing 4.75$ mm and lengths between 8 and 13 mm.

To complement this kit, gmi® has the PEAK guided surgery drill Kit (Ref. KYCoF3052 - see instrumental catalogue), allowing it to be easily expanded for the placement of 1 additional implant system (avantgard PEAK).



Descripción - Description		Un.	Ref.
Fresa Pin $\varnothing 1,50$ mm	Pin drill $\varnothing 1.50$ mm	1	KYFoC6060
Trepante gingival CA $\varnothing 5,10$ mm	HP gingival punch $\varnothing 5.10$ mm	1	KYFoC6066
Fresa inicial $\varnothing 2,5$ mm	Initial drill $\varnothing 2.5$ mm	1	KYFoC6101
Fresa piloto DLC $\varnothing 2,5$ L8 mm	DLC pilot drill $\varnothing 2.5$ L8 mm	1	KYFoC6201
Fresa piloto DLC $\varnothing 2,5$ L10 mm	DLC pilot drill $\varnothing 2.5$ L10 mm	1	KYFoC6202
Fresa piloto DLC $\varnothing 2,5$ L11,5 mm	DLC pilot drill $\varnothing 2.5$ L11.5 mm	1	KYFoC6203
Fresa piloto DLC $\varnothing 2,5$ L13, mm	DLC pilot drill $\varnothing 2.5$ L13 mm	1	KYFoC6204
Fresa piloto DLC $\varnothing 2,5$ L15 mm	DLC pilot drill $\varnothing 2.5$ L15 mm	1	KYFoC6205
Fresa escalonada DLC $\varnothing 2,5/\varnothing 3$ L8 mm	DLC step drill $\varnothing 2.5/\varnothing 3$ L8 mm	1	KYFoC6506
Fresa escalonada DLC $\varnothing 2,5/\varnothing 3$ L10 mm	DLC step drill $\varnothing 2.5/\varnothing 3$ L10 mm	1	KYFoC6507
Fresa escalonada DLC $\varnothing 2,5/\varnothing 3$ L11,5 mm	DLC step drill $\varnothing 2.5/\varnothing 3$ L11.5 mm	1	KYFoC6508
Fresa escalonada DLC $\varnothing 2,5/\varnothing 3$ L13 mm	DLC step drill $\varnothing 2.5/\varnothing 3$ L13 mm	1	KYFoC6509
Fresa escalonada DLC $\varnothing 2,5/\varnothing 3$ L15 mm	DLC step drill $\varnothing 2.5/\varnothing 3$ L15 mm	1	KYFoC6510
Fresa escalonada DLC $\varnothing 3/\varnothing 3,5$ L8 mm	DLC step drill $\varnothing 3/\varnothing 3.5$ L8 mm	1	KYFoC6511
Fresa escalonada DLC $\varnothing 3/\varnothing 3,5$ L10 mm	DLC step drill $\varnothing 3/\varnothing 3.5$ L10 mm	1	KYFoC6512
Fresa escalonada DLC $\varnothing 3/\varnothing 3,5$ L11,5 mm	DLC step drill $\varnothing 3/\varnothing 3.5$ L11.5 mm	1	KYFoC6513
Fresa escalonada DLC $\varnothing 3/\varnothing 3,5$ L13 mm	DLC step drill $\varnothing 3/\varnothing 3.5$ L13 mm	1	KYFoC6514
Fresa escalonada DLC $\varnothing 3/\varnothing 3,5$ L15 mm	DLC step drill $\varnothing 3/\varnothing 3.5$ L15 mm	1	KYFoC6515
Fresa escalonada DLC $\varnothing 3,5/\varnothing 4$ L8 mm	DLC step drill $\varnothing 3.5/\varnothing 4$ L8 mm	1	KYFoC6516
Fresa escalonada DLC $\varnothing 3,5/\varnothing 4$ L10 mm	DLC step drill $\varnothing 3.5/\varnothing 4$ L10 mm	1	KYFoC6517
Fresa escalonada DLC $\varnothing 3,5/\varnothing 4$ L11,5 mm	DLC step drill $\varnothing 3.5/\varnothing 4$ L11.5 mm	1	KYFoC6518
Fresa escalonada DLC $\varnothing 3,5/\varnothing 4$ L13 mm	DLC step drill $\varnothing 3.5/\varnothing 4$ L13 mm	1	KYFoC6519
Fresa escalonada DLC $\varnothing 3,5/\varnothing 4$ L15 mm	DLC step drill $\varnothing 3.5/\varnothing 4$ L15 mm	1	KYFoC6520
Fresa escalonada DLC $\varnothing 4/\varnothing 4,5$ L8 mm	DLC step drill $\varnothing 4/\varnothing 4.5$ L8 mm	1	KYFoC6521
Fresa escalonada DLC $\varnothing 4/\varnothing 4,5$ L10 mm	DLC step drill $\varnothing 4/\varnothing 4.5$ L10 mm	1	KYFoC6522
Fresa escalonada DLC $\varnothing 4/\varnothing 4,5$ L11,5 mm	DLC step drill $\varnothing 4/\varnothing 4.5$ L11.5 mm	1	KYFoC6523

Descripción - Description		Un.	Ref.
Fresa escalonada DLC $\varnothing 4/\varnothing 4,5$ L13 mm	DLC step drill $\varnothing 4/\varnothing 4.5$ L13 mm	1	KYFoC6524
Fresa cortical DLC $\varnothing 3,2$ mm	DLC cortical drill $\varnothing 3.2$ mm	1	KYFoC6401
Fresa cortical DLC $\varnothing 3,55$ mm	DLC cortical drill $\varnothing 3.55$ mm	1	KYFoC6402
Fresa cortical DLC $\varnothing 3,9$ mm	DLC cortical drill $\varnothing 3.9$ mm	1	KYFoC6403
Fresa cortical DLC $\varnothing 4,4$ mm	DLC cortical drill $\varnothing 4.4$ mm	1	KYFoC6404
Fresa cortical DLC $\varnothing 4,9$ mm	DLC cortical drill $\varnothing 4.9$ mm	1	KYFoC6405
Llave carraca corta Hex-1,20 mm	Short Hex-1.20 mm ratchet wrench	1	KYLoFo128
Adaptador Hex-4,00 mm LLCIP	Hex-4.00 mm adapter TIRW	1	KYLoC6054
Adaptador Hex-4,00 mm CA	Hex-4.00 mm adapter HP	1	KYLoC6055
Extractor transportadores	Mounters extraction wrench	1	KYLoC6115
Transportadores NP/RP + tornillo	Implant carriers NP/RP + screw	2	KYLoF6107
Transportadores WP + tornillo	Implant carriers WP + screw	2	KYLoF6108
Llave directa NP/RP CA	Direct HP wrench NP/RP	1	KYLoF6111
Llave directa WP CA	Direct HP wrench WP	1	KYLoF6112
Llave directa NP/RP LLCIP	Direct TIRW NP/RP wrench	1	KYLoF6113
Llave directa WP LLCIP	Direct TIRW WP wrench	1	KYLoF6114
Pin lateral férula	Lateral pin	3	KYLoC6059
Llave carraca IP	TI ratchet wrench	1	KYLoF0113
Llave transportador plana 45°	45° implant carrier manual wrench	1	KYLoC0093

*Todas las referencias se venden por separado como recambios
*All references are sold separately as spare parts

Accesorios - Accessories		Un.	Ref.
Casquillo pin lateral férula	Sleeve for lateral pin	5	KYLoF6061
Casquillo férula $\varnothing 5,10$ mm	Sleeve $\varnothing 5.10$ mm	5	KYLoF6102

Kit quirúrgico gmi® PEAK - gmi® PEAK surgical kit

El kit quirúrgico gmi® PEAK (Ref. KYCoF3054) está formado por una caja autoclavable fabricada en resina técnica de alta resistencia, que contiene todo el material necesario para la correcta colocación de los sistemas de implantes dentales frontier PEAK y avantgard PEAK. Los componentes se encuentran dispuestos de tal manera que sea sencillo encontrar en cada momento el instrumento necesario para cada fase de la intervención.

Los kits quirúrgicos gmi® se distribuyen en cajas confeccionadas en polímero técnico de alta resistencia y deben esterilizarse en autoclave de calor húmedo antes de su uso a una temperatura máxima de 134°C.

Para complementar este kit gmi® dispone del **Kit de fresas frontier/avantgard** (Ref. KYCoF3055 - *ver catálogo de instrumental*), permitiendo ampliar de forma fácil y práctica su uso para la colocación de 2 sistemas de implantes adicionales (frontier y avantgard).

gmi® PEAK (Ref. KYCoF3054) surgical kit consists of an autoclavable case made of high strength resin, containing all the necessary material for the correct positioning of frontier PEAK and avantgard PEAK dental implant systems. The components are arranged in such a way to be easy to find in each moment and in any stage of the intervention.

gmi® surgical kits are distributed in boxes made of high strength technical polymer, and must be sterilized in a moist heat autoclave before use at a maximum temperature of 134°C.

To complement this kit, gmi® has the **frontier/avantgard drill Kit** (Ref. KYCoF3055 - *see instrumental catalogue*), allowing it to be easily expanded for the placement of 2 additional implant systems (frontier and avantgard).



KYCoF3054



KYCoF3061



Ref. KYCoF3061 - Kit para el sistema gmi® avantgard PEAK únicamente, sin las llaves exclusivas del sistema frontier PEAK (*ver tabla, resaltado en rojo*).

Ref. KYCoF3061 - Kit for gmi® avantgard PEAK system only, without the wrenches exclusive to the frontier PEAK system (*see table, highlighted in red*).

Descripción - Description		Un.	Ref.
Fresa inicial ø2,0 mm	Initial drill ø2.0 mm	1	KYFoC1401
Fresa piloto ø2,50 mm	Pilot drill ø2.50 mm	1	KYFoC2250
Fresa cónica ø3,20 mm	Conical drill ø3.20 mm	1	KYFoC7032
Fresa cónica ø3,70 mm	Conical drill ø3.70 mm	1	KYFoC7037
Fresa cónica ø4,20 mm	Conical drill ø4.20 mm	1	KYFoC7042
Fresa cortical ø3,20 mm	Cortical drill ø3.20 mm	1	KYFoC4333
Fresa cortical ø3,65 mm	Cortical drill ø3.65 mm	1	KYFoC4337
Fresa cortical ø4,15 mm	Cortical drill ø4.15 mm	1	KYFoC4342
Fresa cortical ø4,65 mm	Cortical drill ø4.65 mm	1	KYFoC4347
Fresa escalonada ø2,50 / ø2,80 mm	Step drill ø2.50 / ø2.80 mm	1	KYFoC5129
Fresa escalonada ø3,20 / ø3,65 mm	Step drill ø3.20 / ø3.65 mm	1	KYFoC5137
Fresa escalonada ø3,70 / ø4,15 mm	Step drill ø3.70 / ø4.15 mm	1	KYFoC5142
Fresa escalonada ø4,15 / ø4,65 mm	Step drill ø4.15 / ø4.65 mm	1	KYFoC5147
Indicador profundidad ø2,50 mm	Depth gauge ø2.50 mm	1	KYLoC0165
Indicador profundidad cónico ø3,20 mm	Conical depth gauge ø3.20 mm	1	KYLoC0159
Indicador profundidad cónico ø3,70 mm	Conical depth gauge ø3.70 mm	1	KYLoC0160
Indicador profundidad cónico ø4,20 mm	Conical depth gauge ø4.20 mm	1	KYLoC0161
Llave carraca IP	TI ratchet wrench	1	KYLoF0113
Llave-transportador HEX - 2,45 mm CA	HEX-2.45 mm implant carrier HP wrench	1	KYLoF0091
Llave-transportador HEX - 2,45 mm IP corta	Short HEX-2.45 mm implant carrier TI wrench	1	KYLoF0096
Llave-transportador HEX - 2,45 mm IP larga	Long HEX-2.45 mm implant carrier TI wrench	1	KYLoF0111
Llave Avantgard NP/RP CA corta	Short Avantgard NP/RP HP wrench	1	KYLoF0151
Llave Avantgard NP/RP IP corta	Short Avantgard NP/RP TI wrench	1	KYLoF0157
Llave Avantgard NP/RP IP larga	Long Avantgard NP/RP TI wrench	1	KYLoF0162
Alargador fresas	Drill extender	1	KYLoC0023
Paralelizador ø2,00 / ø2,80 mm	Paralleling pin ø2.00 / ø2.80 mm	3	KYLoC0078
Llave carraca corta HEX-1,20 mm	Short HEX-1.20 mm ratchet wrench	1	KYLoF0128
Llave carraca larga HEX-1,20 mm	Long HEX-1.20 mm ratchet wrench	1	KYLoF0129

Kit cirugía guiada gmi® avantgard PEAK - gmi avantgard PEAK guided surgery kit

El kit de cirugía guiada gmi® avantgard PEAK (Ref. KYCoF3050) está formado por una caja autoclavable fabricada en resina técnica de alta resistencia, que contiene todo el material necesario para efectuar cirugías totalmente guiadas de implantes gmi® avantgard PEAK de $\varnothing 3,30$ / $\varnothing 3,75$ / $\varnothing 4,25$ y $\varnothing 4,75$ mm y longitudes comprendidas entre 8 y 13 mm.

Para complementar este kit gmi® dispone del Kit de fresas de cirugía guiada frontier/avantgard (Ref. KYCoF3051 - *ver catálogo de instrumental*), permitiendo ampliar de forma fácil y práctica su uso para la colocación de 1 sistema de implantes adicional (avantgard).

gmi® avantgard PEAK (Ref. KYCoF3050) guided surgery kit consists of an autoclavable case made of high strength resin, containing all the necessary material for performing totally guided surgeries with gmi® avantgard PEAK implants of $\varnothing 3.30$ / $\varnothing 3.75$ / $\varnothing 4.25$ and $\varnothing 4.75$ mm and lengths between 8 and 13 mm.

To complement this kit, gmi® has the frontier/avantgard guided surgery drill Kit (Ref. KYCoF3051 - *see instrumental catalogue*), allowing it to be easily expanded for the placement of 1 additional implant system (avantgard).



Descripción - Description		Un.	Ref.
Fresa Pin $\varnothing 1,50$ mm	Pin drill $\varnothing 1.50$ mm	1	KYFoC6060
Trepante gingival CA $\varnothing 5,10$ mm	HP gingival punch $\varnothing 5.10$ mm	1	KYFoC6066
Fresa inicial $\varnothing 2,5$ mm	Initial drill $\varnothing 2.5$ mm	1	KYFoC6101
Fresa piloto DLC $\varnothing 2,5$ L8 mm	DLC pilot drill $\varnothing 2.5$ L8 mm	1	KYFoC6206
Fresa piloto DLC $\varnothing 2,5$ L10 mm	DLC pilot drill $\varnothing 2.5$ L10 mm	1	KYFoC6207
Fresa piloto DLC $\varnothing 2,5$ L11,5 mm	DLC pilot drill $\varnothing 2.5$ L11.5 mm	1	KYFoC6208
Fresa piloto DLC $\varnothing 2,5$ L13 mm	DLC pilot drill $\varnothing 2.5$ L13 mm	1	KYFoC6209
Fresa piloto DLC $\varnothing 2,5$ L15 mm	DLC pilot drill $\varnothing 2.5$ L15 mm	1	KYFoC6210
Fresa escalonada DLC $\varnothing 2,5/\varnothing 2,8$ L8 mm	DLC step drill $\varnothing 2.5/\varnothing 2.8$ L8 mm	1	KYFoC6525
Fresa escalonada DLC $\varnothing 2,5/\varnothing 2,8$ L10 mm	DLC step drill $\varnothing 2.5/\varnothing 2.8$ L10 mm	1	KYFoC6526
Fresa escalonada DLC $\varnothing 2,5/\varnothing 2,8$ L11,5 mm	DLC step drill $\varnothing 2.5/\varnothing 2.8$ L11.5 mm	1	KYFoC6527
Fresa escalonada DLC $\varnothing 2,5/\varnothing 2,8$ L13 mm	DLC step drill $\varnothing 2.5/\varnothing 2.8$ L13 mm	1	KYFoC6528
Fresa escalonada DLC $\varnothing 2,5/\varnothing 2,8$ L15 mm	DLC step drill $\varnothing 2.5/\varnothing 2.8$ L15 mm	1	KYFoC6529
Fresa cónica DLC $\varnothing 3,2$ L8 mm	DLC conical drill $\varnothing 3.2$ L8 mm	1	KYFoC6706
Fresa cónica DLC $\varnothing 3,2$ L10 mm	DLC conical drill $\varnothing 3.2$ L10 mm	1	KYFoC6707
Fresa cónica DLC $\varnothing 3,2$ L11,5 mm	DLC conical drill $\varnothing 3.2$ L11.5 mm	1	KYFoC6708
Fresa cónica DLC $\varnothing 3,2$ L13 mm	DLC conical drill $\varnothing 3.2$ L13 mm	1	KYFoC6709
Fresa cónica DLC $\varnothing 3,2$ L15 mm	DLC conical drill $\varnothing 3.2$ L15 mm	1	KYFoC6710
Fresa cónica DLC $\varnothing 3,7$ L8 mm	DLC conical drill $\varnothing 3.7$ L8 mm	1	KYFoC6711
Fresa cónica DLC $\varnothing 3,7$ L10 mm	DLC conical drill $\varnothing 3.7$ L10 mm	1	KYFoC6712
Fresa cónica DLC $\varnothing 3,7$ L11,5 mm	DLC conical drill $\varnothing 3.7$ L11.5 mm	1	KYFoC6713
Fresa cónica DLC $\varnothing 3,7$ L13 mm	DLC conical drill $\varnothing 3.7$ L13 mm	1	KYFoC6714
Fresa cónica DLC $\varnothing 3,7$ L15 mm	DLC conical drill $\varnothing 3.7$ L15 mm	1	KYFoC6715
Fresa cónica DLC $\varnothing 4,2$ L8 mm	DLC conical drill $\varnothing 4.2$ L8 mm	1	KYFoC6716
Fresa cónica DLC $\varnothing 4,2$ L10 mm	DLC conical drill $\varnothing 4.2$ L10 mm	1	KYFoC6717
Fresa cónica DLC $\varnothing 4,2$ L11,5 mm	DLC conical drill $\varnothing 4.2$ L11.5 mm	1	KYFoC6718

Descripción - Description		Un.	Ref.
Fresa cónica DLC $\varnothing 4,2$ L13 mm	DLC conical drill $\varnothing 4.2$ L13 mm	1	KYFoC6719
Fresa cortical DLC $\varnothing 3,2$ mm	DLC cortical drill $\varnothing 3.2$ mm	1	KYFoC6406
Fresa cortical DLC $\varnothing 3,65$ mm	DLC cortical drill $\varnothing 3.65$ mm	1	KYFoC6407
Fresa cortical DLC $\varnothing 4,15$ mm	DLC cortical drill $\varnothing 4.15$ mm	1	KYFoC6408
Fresa cortical DLC $\varnothing 4,65$ mm	DLC cortical drill $\varnothing 4.65$ mm	1	KYFoC6409
Llave carraca corta Hex-1,20 mm	Short Hex-1.20 mm ratchet wrench	1	KYLoF0128
Adaptador Hex-4,00 mm LLCIP	Hex-4.00 mm adapter TIRW	1	KYLoC6054
Adaptador Hex-4,00 mm CA	Hex-4.00 mm adapter HP	1	KYLoC6055
Extractor transportadores	Mounters extraction wrench	1	KYLoC6115
Transportadores NP/RP + tornillo	Implant carriers NP/RP + screw	2	KYLoF6107
Transportadores WP + tornillo	Implant carriers WP + screw	2	KYLoF6108
Llave directa NP/RP CA	Direct HP wrench NP/RP	1	KYLoF6111
Llave directa WP CA	Direct HP wrench WP	1	KYLoF6112
Llave directa NP/RP LLCIP	Direct TIRW NP/RP wrench	1	KYLoF6113
Llave directa WP LLCIP	Direct TIRW WP wrench	1	KYLoF6114
Pin lateral férula	Lateral pin	3	KYLoC6059
Llave carraca IP	TI ratchet wrench	1	KYLoF0113
Llave transportador plana 45°	45° implant carrier manual wrench	1	KYLoC0093

*Todas las referencias se venden por separado como recambios
 *All references are sold separately as spare parts

Accesorios - Accessories			
Descripción - Description		Un.	Ref.
Casquillo pin lateral férula	Sleeve for lateral pin	5	KYLoF6061
Casquillo férula $\varnothing 5,10$ mm	Sleeve $\varnothing 5.10$ mm	5	KYLoF6102

Especificaciones técnicas - Technical specifications

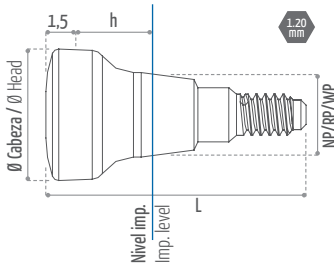

Pilares de cicatrización - Healing abutments (mm)				
Referencia - Reference	L	h	Ø Cabeza - Ø Head	Plataforma - Platform
KDPOC4012	9,10	1,50	4,00	NP
KDPOC4013	10,10	2,50		
KDPOC4014	11,10	3,50		
KDPOC4015	12,10	4,50		
KDPOC4016	9,10	1,50	5,00	RP
KDPOC4017	10,10	2,50		
KDPOC4018	11,10	3,50		
KDPOC4019	12,10	4,50		
KDPOC4001	9,10	1,50	5,10	WP
KDPOC4002	10,10	2,50		
KDPOC4003	11,10	3,50		
KDPOC4004	12,10	4,50		
KDPOC4009	10,10	2,50	6,00	WP
KDPOC4010	11,10	3,50		
KDPOC4011	12,10	4,50		
KDPOC4005	9,10	1,50		
KDPOC4006	10,10	2,50	6,10	WP
KDPOC4007	11,10	3,50		
KDPOC4008	12,10	4,50		

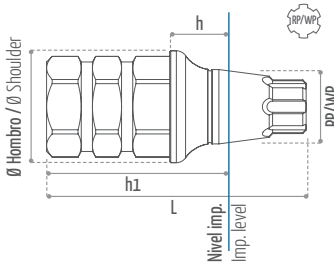

Pilares fresables - Millable-implant abutments (mm)					
Referencia - Reference	L	h	h1	Ø Hombro - Ø Shoulder	Plataforma - Platform
KDBoF4001	11,60	2,50	8,00	5,00	RP
KDBoF4002	11,60	2,50	8,00	5,50	WP
KDBoF4003	11,60	2,50	8,00	6,40	

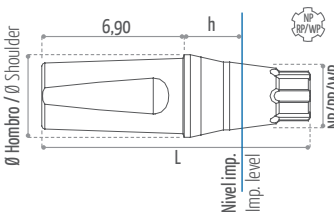

Pilares rectos - Straight abutments (mm)				
Referencia - Reference	L	h	Ø Hombro - Ø Shoulder	Plataforma - Platform
KDMoF4035	12,00	1,50	Ø 4,00	NP
KDMoF4036	13,00	2,50		
KDMoF4037	14,00	3,50		
KDMoF4038	15,00	4,50		
KDMoF4001	12,00	1,50	Ø 4,00	RP
KDMoF4002	13,00	2,50		
KDMoF4003	14,00	3,50		
KDMoF4004	15,00	4,50		
KDMoF4005	12,00	1,50	Ø 5,00	WP
KDMoF4006	13,00	2,50		
KDMoF4007	14,00	3,50		
KDMoF4008	15,00	4,50		
KDMoF4009	12,00	1,50	Ø 6,00	WP
KDMoF4010	13,00	2,50		
KDMoF4011	14,00	3,50		
KDMoF4012	15,00	4,50		

Especificaciones técnicas - Technical specifications

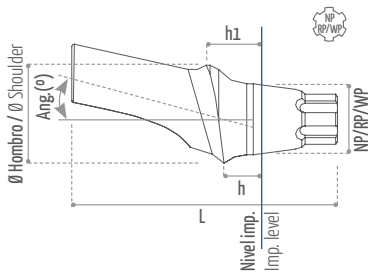

Pilares inclinados - Angled abutments (mm)						
Referencia - Reference	L	h	h1	Ang. (°)	Ø Hombro - Ø Shoulder	Plataforma - Platform
KDMoF4039	12,30	1,80	2,50	10°	Ø 4,00	NP
KDMoF4040	14,30	3,60	4,50	10°		
KDMoF4041	12,00	1,80	2,50	20°		
KDMoF4042	14,00	3,60	4,50	20°		
KDMoF4013	12,30	1,80	2,50	15°	Ø 4,50	RP
KDMoF4014	14,30	3,60	4,50	15°		
KDMoF4015	12,00	1,80	2,50	20°		
KDMoF4016	14,00	3,60	4,50	20°		
KDMoF4017	12,30	1,60	2,50	15°	Ø 5,30	WP
KDMoF4018	14,30	3,60	4,50	15°	Ø 5,60	
KDMoF4019	12,00	1,60	2,50	20°	Ø 5,30	
KDMoF4020	14,00	3,60	4,50	20°	Ø 5,60	

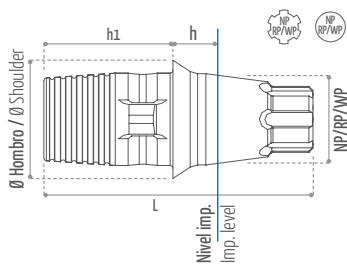

Base de titanio - Titanium base (mm)						
Referencia - Reference	L	h	h1	Ø Hombro - Ø Shoulder	Conexión - Connection	Plataforma - Platform
KDMoF4043	9,10	1,50	4,70	Ø 4,30	Anti-rotatoria - Non-rotary	NP
KDMoF4045	7,50	1,50	4,70	Ø 4,30	Rotatoria - Rotary	
KDMoF4044	10,6	3,00	4,70	Ø 4,30	Anti-rotatoria - Non-rotary	
KDMoF4046	9,00	3,00	4,70	Ø 4,30	Rotatoria - Rotary	
KDMoF4021	9,80	1,50	4,70	Ø 4,30	Anti-rotatoria - Non-rotary	RP
KDMoF4023	8,30	1,50	4,70	Ø 4,30	Rotatoria - Rotary	
KDMoF4025	11,30	3,00	4,70	Ø 4,30	Anti-rotatoria - Non-rotary	
KDMoF4027	9,80	3,00	4,70	Ø 4,30	Rotatoria - Rotary	
KDMoF4022	9,80	1,50	4,70	Ø 5,30	Anti-rotatoria - Non-rotary	WP
KDMoF4024	8,30	1,50	4,70	Ø 5,30	Rotatoria - Rotary	
KDMoF4026	11,30	3,00	4,70	Ø 5,30	Anti-rotatoria - Non-rotary	
KDMoF4028	9,80	3,00	4,70	Ø 5,30	Rotatoria - Rotary	

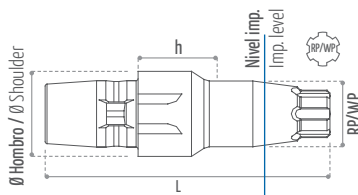

Pilar escaneo - Scan abutment (mm)				
Referencia - Reference	L	h	Ø Hombro - Ø Shoulder	Plataforma - Platform
KDioF4001	14,40	6,30	Ø 4,30	RP
KDioF4002	14,40	6,30	Ø 4,30	WP

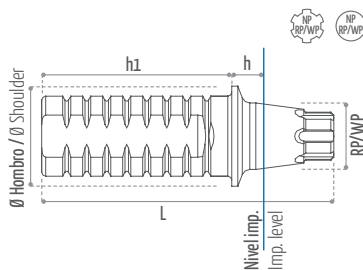

Pilares provisionales - Temporary cylinders (mm)						
Referencia - Reference	L	h	h1	Ø Hombro - Ø Shoulder	Conexión - Connection	Plataforma - Platform
KDHof4009	13,40	1,50	9,00	Ø 4,20	Anti-rotatoria - Non-rotary	NP
KDHof4010	14,90	3,00	9,00	Ø 4,20		
KDHof4011	11,80	1,50	9,00	Ø 4,20		
KDHof4012	13,30	3,00	9,00	Ø 4,20	Rotatoria - Rotary	RP
KDHof4001	14,60	1,50	9,50	Ø 5,00	Anti-rotatoria - Non-rotary	
KDHof4002	14,60	1,50	9,50	Ø 5,00	Rotatoria - Rotary	
KDHof4003	14,60	1,50	9,50	Ø 6,00	Anti-rotatoria - Non-rotary	
KDHof4004	14,60	1,50	9,50	Ø 6,00	Rotatoria - Rotary	WP

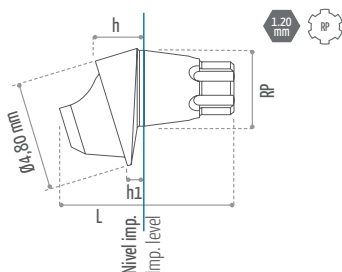

Pilares multi-estético inclinados - Multi-esthetic angled abutments (mm)					
Referencia - Reference	Ang. (°)	L	h	h1	Plataforma - Platform
KDGof4009	17°	8,50	2,50	1,30	RP
KDGof4010	17°	9,50	3,50	2,50	
KDGof4011	30°	9,00	4,00	1,70	

Especificaciones técnicas - Technical specifications

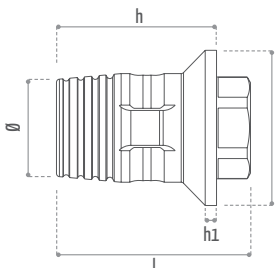
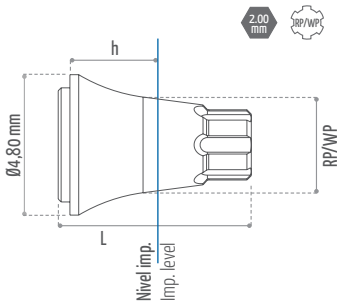
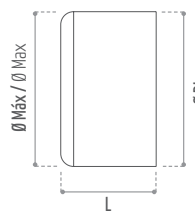
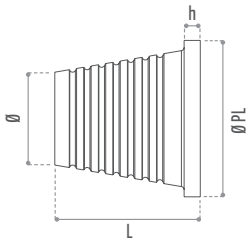
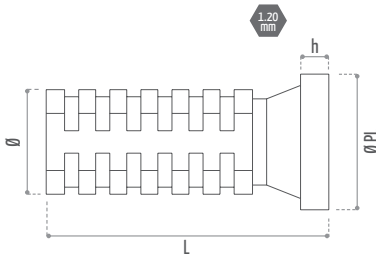
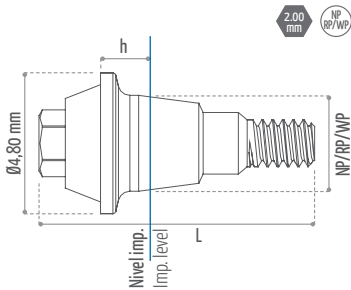

Pilares multi-estético rectos - Multi-esthetic straight abutments (mm)

Referencia - Reference	L	h	Plataforma - Platform
KDGoF4019	9,40	1,50	NP
KDGoF4020	10,40	2,50	
KDGoF4021	11,40	3,50	
KDGoF4022	12,40	4,50	RP
KDGoF4001	9,40	1,50	
KDGoF4002	10,40	2,50	
KDGoF4003	11,40	3,50	
KDGoF4004	12,40	4,50	WP
KDGoF4005	9,40	1,50	
KDGoF4006	10,40	2,50	
KDGoF4007	11,40	3,50	
KDGoF4008	12,40	4,50	

Cilindros provisionales PME - Temporary cylinder MEA (mm)

Referencia - Reference	L	h	Ø	Ø PL
KDGoF0028	10,00	1,00	3,70	4,80

Base titanio PME - Titanium base MEA (mm)

Referencia - Reference	L	h	Ø	Ø PL
KDGoF0035	4,50	0,50	2,85	4,80

Pilares cicatrización PME - Healing abutments MEA (mm)

Referencia - Reference	L	Ø Máx - Ø Max	Ø PL
KDPoF0035	3,80	4,80	4,80
KDPoF0037	3,80	6,00	4,80

Bases bioestéticas - Bioesthetic bases (mm)

Referencia - Reference	L	h	Plataforma - Platform
KDGoF4012	6,60	2,50	RP
KDGoF4013	7,60	3,50	
KDGoF4014	8,60	4,50	
KDGoF4015	6,60	2,50	WP
KDGoF4016	7,60	3,50	
KDGoF4017	8,60	4,50	

Base titanio BE - BE titanium base (mm)

Referencia - Reference	L	h	h1	Ø	Ø PL
KDGoF4018	6,00	4,95	0,35	3,00	4,80

Especificaciones técnicas - Technical specifications

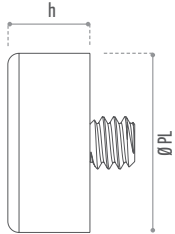

Pilar cicatrización BE - BE healing abutment (mm)		
Referencia - Reference	h	Ø PL
KDPoF0038	2,20	4,80

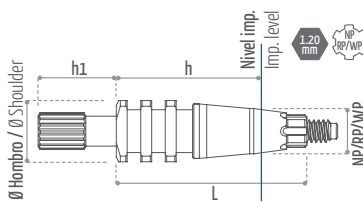

Tomas impresión cubeta abierta (CA) - Open tray (OT) impression coping (mm)						
Referencia - Reference	L	h	h1	Ø Hombro - Ø Shoulder	Tornillo - Screw	Plataforma - Platform
KDSof4005	13,30	10,50	5,80	Ø 5,00	Largo - Long	NP
KDSof4001	14,00	10,50	5,80	Ø 5,00	Largo - Long	RP
KDSof4003	14,00	10,50	---	Ø 5,00	Corto - Short	
KDSof4002	14,00	10,50	5,80	Ø 6,00	Largo - Long	WP
KDSof4004	14,00	10,50	---	Ø 6,00	Corto - Short	

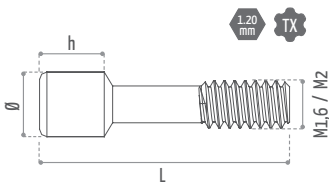

Tornillo clínica - Clinic screw (mm)				
Referencia - Reference	L	h	Ø	Plataforma - Platform
⊕ KDToc4003	8,50	2,20	2,20	
⊕ KDToc4021	7,80	1,50	2,20	NP - RP
⊕ KDToc4004	8,50	2,20	2,40	
⊕ KDToc4022	7,80	1,50	2,40	WP

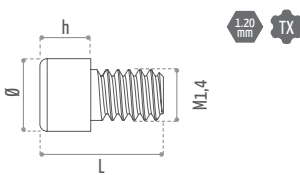

Tornillo PME - MEA screw (mm)				
Referencia - Reference	L	h	Ø	Plataforma - Platform
⊕ KDToc0056	3,40	1,40	2,00	
⊕ KDToc0070	3,40	1,40	2,10	NP - RP - WP

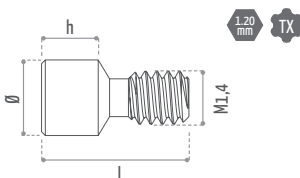

Tornillo BE - BE screw (mm)				
Referencia - Reference	L	h	Ø	Plataforma - Platform
⊕ KDToc4016	3,90	1,50	2,00	
⊕ KDToc0074	3,90	1,50	2,10	RP - WP

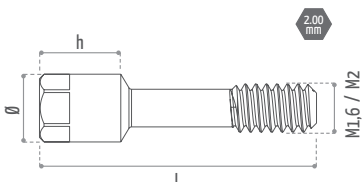

Tornillo base BE - BE base screw (mm)				
Referencia - Reference	L	h	Ø	Plataforma - Platform
KDToc4013	9,20	2,50		
KDToc4014	10,20	3,50	2,25	RP
KDToc4015	11,20	4,50		
KDToc4017	9,20	2,50		
KDToc4018	10,20	3,50	2,25	WP
KDToc4019	11,20	4,50		

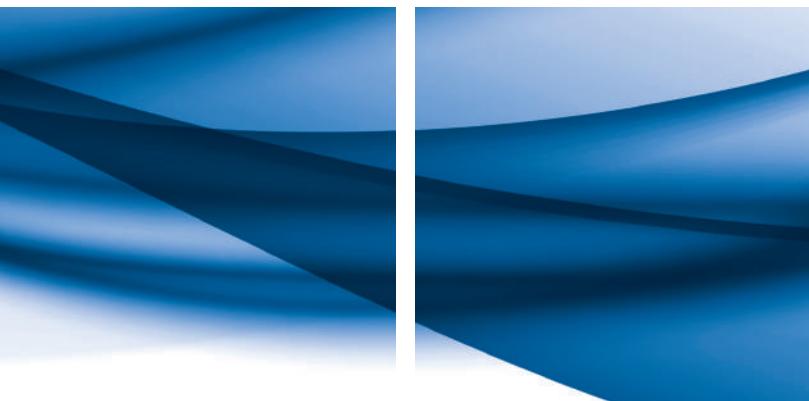

 **GMI
Dental Implantology, S.L.**

Pol. Ind. El Segre
C/ Enginyer Mies 705-B
25191 Lleida (SPAIN)
Tel. (+34) 973 184 350
info@gmidental.com
www.gmidental.com



Distribuido por:
Distributed by:

