



SISTEMA DE IMPLANTES  
IMPLANT SYSTEM

[www.gmidental.com](http://www.gmidental.com)



Implantes dentales de conexión externa  
External connection dental implants

Made in Spain





## Índice - Summary

### CARACTERÍSTICAS GENERALES

- Tratamiento superficial / estudios
- Recomendaciones de uso
- Descripción del etiquetado

### SISTEMA DE IMPLANTES

- Implantes dentales **gmi phoenix**
- Protocolo de inserción de implantes **gmi phoenix**
- Gama de implantes **gmi phoenix**
- Secuencias fresado para implantes **gmi phoenix**

### ADITAMENTOS

- Pilares cicatrización **gmi phoenix**
- Pilares inclinados estéticos **gmi phoenix**
- Pilares rectos **gmi phoenix**
- Pilares transportador **gmi phoenix**
- Pilares bola **gmi phoenix**
- Pilares multi-estético **gmi phoenix**
- Réplicas **gmi phoenix**
- Tomas de impresión **gmi phoenix**
- Calcinables **gmi phoenix**
- Tornillos clínica y laboratorio **gmi phoenix**
- Tornillos PME **gmi phoenix**
- Pares recomendados de apriete

### KIT QUIRÚRGICO GMI PHOENIX

### ESPECIFICACIONES TÉCNICAS

### KEY FEATURES

- Surface treatment / studies 4
- Recommendations of use 6
- Labelling description 7

### IMPLANT SYSTEM

- **gmi phoenix** dental implants 8
- Insertion sequence for **gmi phoenix** implants 9
- **gmi phoenix** implants range 10
- Drilling sequences for **gmi phoenix** implants 11

### ATTACHMENTS

- **gmi phoenix** healing abutments 13
- **gmi phoenix** esthetic angled abutments 15
- **gmi phoenix** straight abutments 16
- **gmi phoenix** implant carrier abutments 17
- **gmi phoenix** ball abutments 18
- **gmi phoenix** multi-esthetic abutments 20
- **gmi phoenix** replicas 23
- **gmi phoenix** impression coping 24
- **gmi phoenix** castables 26
- **gmi phoenix** clinic and laboratory screws 28
- **gmi phoenix** MEA screws 29
- Recommended tightening torques 30

### GMI PHOENIX SURGICAL KIT 31

### TECHNICAL SPECIFICATIONS 32



## Tratamiento superficial ADS®

### ADS® surface treatment

Para favorecer la adherencia y el crecimiento de las células óseas se ha tratado la superficie exterior del implante con el exclusivo sistema ADS® (Advanced Double-Grip Surface) que combina un microbulado con corindón blanco con un ataque ácido para obtener una rugosidad no uniforme, que maximiza la superficie de contacto entre el implante y el hueso y por tanto, mejora la estabilidad y la unión entre ellos.

To promote the adhesion and growth of bone cells, the outer surface of the implant has been treated with the exclusive ADS® treatment (Advanced Double-Grip Surface) which combines a white corundum micro-bubble treatment and acid etching, for a non-smooth roughness that maximizes the contact surface between implant and bone and therefore improves stability and adhesion between them.

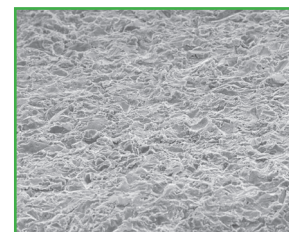
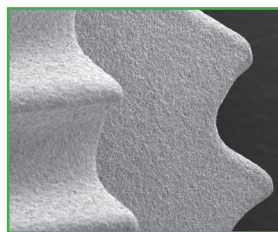
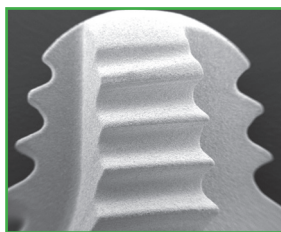

El tratamiento ADS® es el resultado de una serie de colaboraciones con institutos y universidades, así como estudios y ensayos propios que nos permiten controlar y validar la respuesta biológica óptima de la superficie del implante: se han efectuado tanto estudios químicos (estudios de dispersión rayos X para conocer la composición del implante y su superficie) como topográficos (estudios de rugosidad), así como estudios biológicos (estudios de respuesta in vivo en animales) y estudios clínicos.

The ADS® treatment is the result of a series of collaborations with institutes and universities, as well as our own research and tests, that allow us to monitor and validate the optimal biological response to the implant surface: chemical (X-ray scattering studies to find out the composition of the implant and its surface) and topography studies (roughness studies) have been carried out, as well as biological (in vivo response studies in animals) and clinical studies.

## Estudios de composición

### Composition studies

Los estudios efectuados por dispersión de rayos X demuestran que sobre la superficie del implante solo se encuentra titanio y oxígeno, que son los componentes básicos de la capa de óxido que se forma en el proceso de pasivado del implante, y que es la que le confiere la excelente resistencia a la corrosión.

X-ray scattering studies show that the surface of the implants is only made of titanium and oxygen, which are the basic components of the oxide layer that is formed in the implant passivation process and that gives it its excellent corrosion resistance.

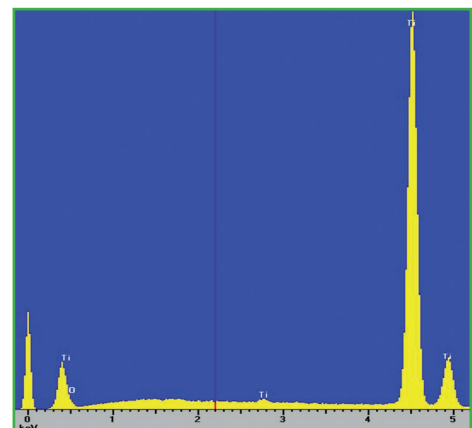

## Estudios de la topografía de la superficie

### Surface topography studies

Para controlar y conocer la topografía de la superficie del implante, se han efectuado estudios de rugosidad tanto con rugosímetros de contacto, como con técnicas SEM (Scanning Electron Microscope) y CLSM (Confocal Laser Scanning Microscope), permitiéndonos obtener y controlar los valores de la media aritmética de la rugosidad (Ra) dentro de los parámetros recomendados en las publicaciones internacionales.

In order to control and identify the topography of the implant surface, roughness studies were performed with profilometer, as well as with techniques such as SEM (Scanning Electron Microscope) and CLSM (Confocal Laser Scanning Microscope), allowing to obtain and control the mean roughness (Ra) values within the parameters recommended in international publications.

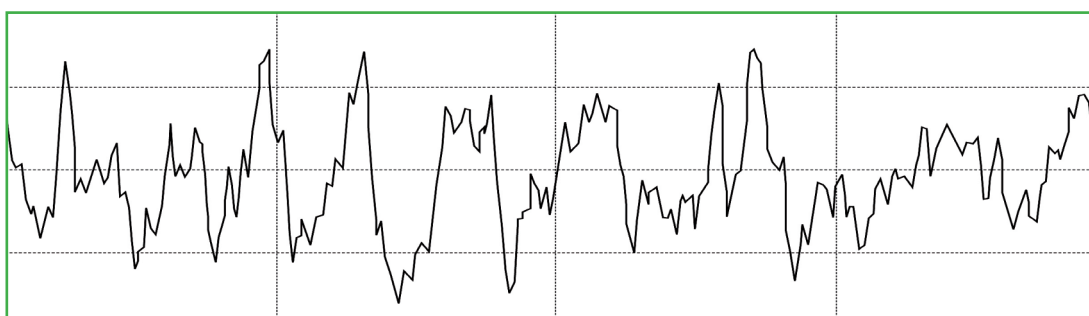

Perfil de rugosidad obtenido con HOMMEL-WERKE T1000 • Roughness profile obtained with HOMMEL-WERKE T1000.

## Estudios de osteointegración

### Osseointegration studies

Para conocer la respuesta biológica de los implantes **gmi**, se han efectuado estudios in vivo colocando los implantes en animales, dejándolos sin carga durante el proceso de cicatrización y efectuando un estudio histológico que demuestra la excelente respuesta de las células óseas y la osteointegración completa del implante.

To determine the biological response of **gmi** implants, in vivo studies were conducted by inserting the implants on animals, leaving them without load during the healing process and performing a histological study to prove the excellent response of the bone cells and the complete osseointegration of the implant.

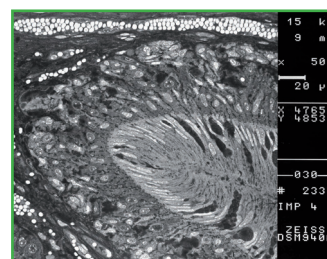
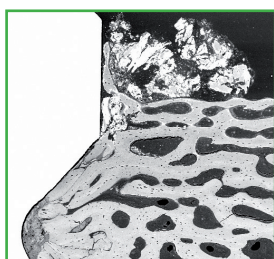
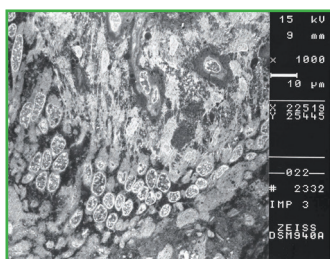

SEM-BSE: detalles ultraestructurales de las células en biofilm sobre el implante. • SEM-BSE: ultrastructural details of cells in biofilm on the implant.

## Recomendaciones de uso - Recommendations of use

La gama de implantes **gmi** modelo **phoenix** ha sido diseñada y testada para ser colocada como restauración unitaria, con una inclinación máxima de 30 grados respecto al plano perpendicular al plano oclusal, según el siguiente diagrama.

The **gmi phoenix** implant range was designed and tested to be inserted as a single restoration, with a 30-degree maximum inclination to the perpendicular plane to the occlusal plane, in accordance with the following diagram.

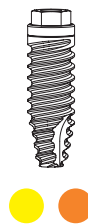
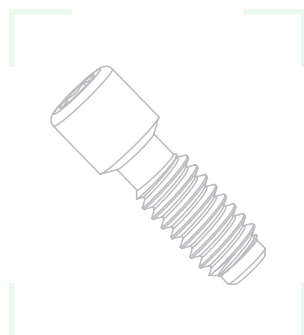
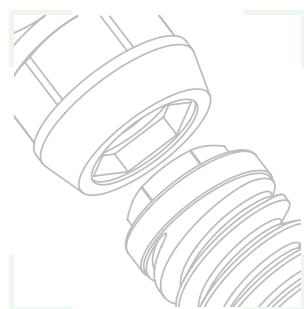
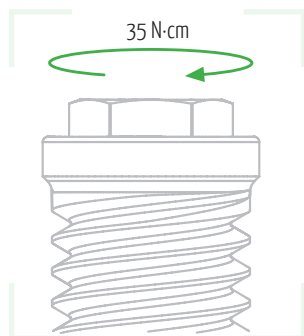

Ø3,30-Ø3,75 mm

Incisivos  
(Excepto centrales maxilares)  
Incisors  
(Except central maxillary incisors)



Ø4,00 mm

Caninos • Canines  
Premolares • Premolars  
Incisivos centrales maxilares  
Central maxillary incisors

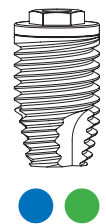

Ø5,00-Ø6,00 mm

Molares  
Molars

Los implantes **gmi** modelo **phoenix** han sido diseñados para ser insertados aplicando un par de apriete de 35-40 N-cm, aunque pueden soportar un par máximo de apriete de 60 N-cm. **gmi** recomienda la inserción manual del implante con la llave de carraca dinamométrica para asegurar que no se sobrepasan estos valores.

The **gmi phoenix** implant range is designed to be inserted applying a 35-40 N-cm torque, although it can bear a maximum tightening torque of 60 N-cm. **gmi** recommends manual insertion of the implant with a dynamometric ratchet wrench to ensure that these values are not exceeded.

La gama de implantes y aditamentos protésicos **gmi** modelo **phoenix**, han sido diseñados y fabricados con unas tolerancias estudiadas para mantener unos ajustes que minimizan el juego entre los componentes, y por tanto garantizan la estabilidad de la conexión. **gmi** recomienda utilizar aditamentos originales para asegurar el perfecto ajuste entre los componentes de la restauración.

The **gmi phoenix** range of implants and prosthetic attachments are designed and manufactured with tolerances intended to maintain adjustments that minimize the clearance between components and therefore guarantee the stability of the connection. **gmi** recommends the use of original attachments to ensure a perfect fit between the components of the restoration.

Para evitar deformaciones previas del tornillo clínica, **gmi** recomienda reservar su uso únicamente para el apriete definitivo de la prótesis. Para realizar los ajustes de la fase protésica se recomienda utilizar el tornillo laboratorio.

To prevent prior deformation of the clinic screw, **gmi** recommends restricting its use only for the final tightening of the prosthesis. To make adjustments during the prosthetic procedures, use of the laboratory screw is recommended.

## Descripción del etiquetado - Labelling description

En la tabla se detallan todos los símbolos que aparecen en las etiquetas y cajas del sistema de implantes **gmi phoenix**, con su correspondiente descripción.

In the chart are detailed all the symbols appearing on the **gmi phoenix** implant system's labelling and packaging and their corresponding description.

1	REF	Referencia - Reference
2	LOT	Número de Lote - Batch code
3		Fecha de caducidad - Used-by-date
4	UDI	Identificador único de producto Unique device identifier
5	MD	Dispositivo médico - Medical device
6		Fabricante - Manufacturer
7	STERILE R	Esterilizado usando radiación gamma Sterilized using gamma radiation
8		Sistema de barrera estéril único con embalaje de protección exterior Single sterile barrier system with protective packaging outside
9		De un solo uso - Single use only
10		No utilizar si el envase está dañado o abierto Do not use if packaging is damaged or opened
11		No reesterilizar - Do not resterilize
12	MR	RM Condicional: los dispositivos no suponen ningún peligro conocido en un entorno RM específico con condiciones de uso concretas MR Conditional: Items do not pose any known hazards in a specific MR environment with specific conditions of use.
13		Fecha de fabricación Manufacturing date
14		Instrucciones de uso electrónicas* Electronic instructions for use*
15	CE 2797	Marco de conformidad europeo European conformity mark
16	Rx Only	Venta limitada a dentistas o médicos autorizados Sale by or on the order of a licensed dentist
17		No estéril - Non-sterile

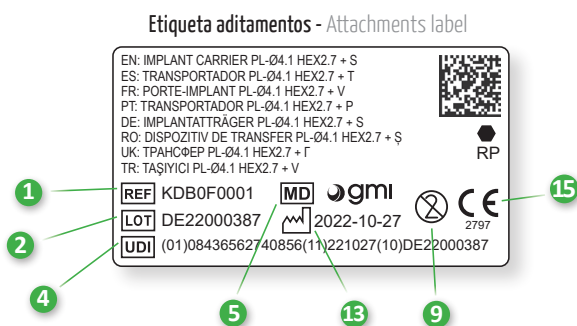
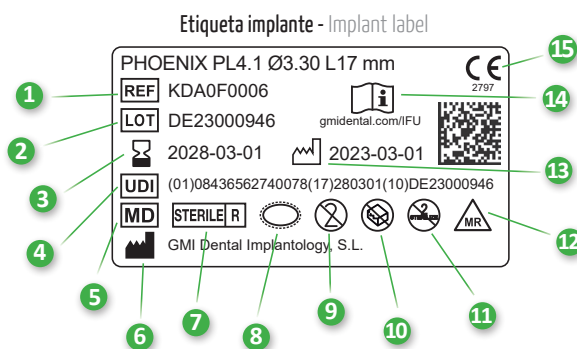

## Especificaciones del DataMatrix de las etiquetas - DataMatrix specifications of labels

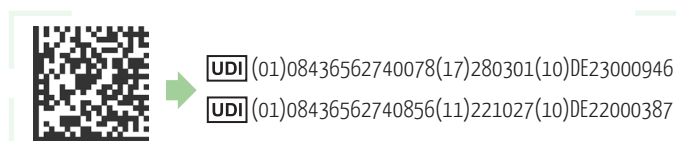

- 01 - GTIN del producto etiquetado - Tagged product GTIN
- 17 - Fecha de caducidad (año/mes/día) - Used-by-date (year/month/day)
- 11 - Fecha de fabricación (año/mes/día) - Manufacturing date (year/month/day)
- 10 - Número de Lote - Batch code

\*Requisitos mínimos para abrir y descargar las instrucciones de uso electrónicas:  
- Conectividad estable a internet.  
- Un dispositivo con un sistema operativo moderno que admita la visualización de PDF.  
- Espacio de almacenamiento adecuado en su dispositivo.  
- Un navegador web como Google Chrome, Mozilla Firefox, Safari, Microsoft Edge u Opera instalado en su dispositivo.  
- Una aplicación de lectura de PDF instalada en su dispositivo.

\*Minimum requirements for downloading and opening the electronic instructions for use:  
- Stable internet connectivity.  
- A device with a modern operating system that supports PDF viewing.  
- Adequate storage space on your device.  
- A web browser such as Google Chrome, Mozilla Firefox, Safari, Microsoft Edge or Opera installed on your device.  
- A PDF reader application installed on your device.

## Implantes dentales gmi phoenix - gmi phoenix dental implants

Los implantes de conexión externa gmi modelo phoenix están mecanizados en titanio grado IV c.p. de la máxima calidad, garantizando así una gran estabilidad química y por tanto una excelente biocompatibilidad. La capa de dióxido de titanio que se forma en la superficie del implante después del proceso de pasivado, y el estudiado diseño del perfil exterior de la rosca aseguran una buena osteointegración y una elevada estabilidad.

La rosca exterior de doble entrada permite disminuir los tiempos quirúrgicos mientras que las formas redondeadas disminuyen las tensiones producidas en la interfase hueso-implante. Además, los fresados auto-roscantes y la ligera conicidad apical evitan el estrés de roscado y facilitan la penetración en el hueso y su retención inicial.

gmi phoenix external connection implants are machined in c.p. grade IV titanium of the highest quality, thus ensuring a high chemical stability and excellent biocompatibility. The titanium oxide layer, that is formed on the implant surface after the passivation process, and the careful design of the outer surface of the thread, guarantee good osseointegration and high stability.

The external dual inlet thread of the implant helps to reduce surgery time. Moreover, the rounded shapes, self-threading millings and slight tapering facilitate implant insertion, reducing tension at the bone-implant interface and thus preventing threading stress-related problems.

### Características generales

#### Key features

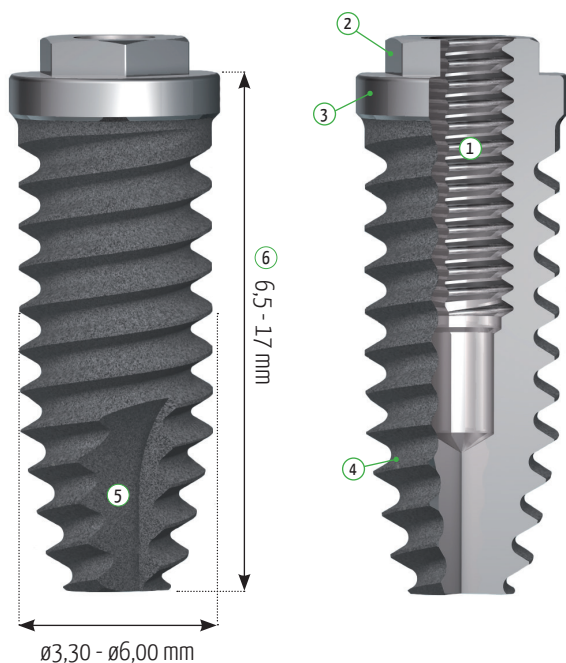

#### ① Rosca interior

Estrecha: M1,8 x 0,35 mm  
 Estándar: M2,0 x 0,40 mm  
 Ancha: M2,0 x 0,40 y M2,5 x 0,45 mm  
 Extra-Ancha: M2,5 x 0,45 mm

#### ② Hexágono externo

Estrecha: E/C 2,40 mm x 1 mm  
 Estándar: E/C 2,70 mm x 0,7 mm  
 Ancha: E/C 2,70 mm x 0,7 mm  
           E/C 3,40 mm x 0,7 mm  
 Extra-Ancha: E/C 3,40 x 0,9 mm

#### ③ Plataforma

#### ④ Rosca Exterior

Paso 1,60 mm  
 Tratamiento superficial ADS

#### ⑤ Fresados auto-roscantes

Longitud Variable  
 3 fresados a 120°

#### ⑥ Longitud

#### ① Internal thread

Narrow: M1.8 x 0.35 mm  
 Standard: M2.0 x 0.40 mm  
 Wide: M2.0 x 0.40 & M2.5 x 0.45 mm  
 Extra wide: M2.5 x 0.45 mm

#### ② External hexagon

Narrow: B/F 2.40 mm x 1 mm  
 Standard: B/F 2.70 mm x 0.7 mm  
 Wide: B/F 2.70 mm x 0.7 mm  
           B/F 3.40 mm x 0.7 mm  
 Extra wide: B/F 3.40 x 0.9 mm

#### ③ Platforms

#### ④ External thread

1.60 mm pitch  
 ADS surface treatment

#### ⑤ Self threading millings

Variable length  
 3 millings at 120°

#### ⑥ Length

	●	● ● ●	●	●
④	$\varnothing 3,30$	$\varnothing 3,30 - \varnothing 3,75 - \varnothing 4,00$	$\varnothing 5,00$	$\varnothing 6,00$
③	$\varnothing 3,30$	$\varnothing 4,10$	$\varnothing 5,10$	$\varnothing 6,00$
②	e/c · b/f - 2,40	e/c · b/f - 2,70	e/c · b/f - 2,70-3,40	e/c · b/f - 3,40
⑥	De 8 a 15 From 8 to 15	De 8 a 17 From 8 to 17	De 6,5 a 13 From 6.5 to 13	De 6,5 a 10 From 6.5 to 10



## Protocolo de inserción de implantes gmi phoenix - Insertion sequence for gmi phoenix implants

Los implantes de conexión externa **gmi phoenix** vienen presentados en una caja de cartón serigrafiada, en cuyo interior se encuentran 3 etiquetas de trazabilidad y un doble envase que contiene el sistema de implantes, siendo el envase secundario de plástico técnico y el envase primario de vidrio Pyrex para asegurar el comportamiento inerte del envase. Una vez envasados en sala blanca, son esterilizados mediante radiación gamma según normativa.

El nuevo sistema de envasado de los implantes **gmi phoenix** consta de un soporte de titanio donde se aloja únicamente el conjunto implante-transportador preparado para ser introducido directamente en boca, utilizando una única llave transportador hex-3,00 mm, diseñada a tal efecto. Este nuevo sistema presenta las siguientes ventajas para el profesional: un mayor control y una mejor visibilidad del proceso de inserción del implante, una mayor facilidad de uso en espacios interdentes reducidos y una reducción en el tiempo de cirugía.\*

**gmi phoenix** external connection implants are packed in a screen-printed cardboard box, with 3 traceability labels and a double packaging containing the implant system, with the secondary packaging made of technical plastic and the primary packaging made of Pyrex glass to ensure the inert performance of the container. Once packaged in a clean room, they are sterilized with gamma radiation according to regulations.

The new packaging system of the **gmi phoenix** implants consists of a titanium support which only houses the implant-implant carrier set, prepared to be inserted directly into the mouth, using a single hex-3.00 mm implant carrier wrench, designed for this purpose. This new system offers the odontologist the following advantages: more control and a better view of the implant insertion process, it is easier to use in reduced interdental spaces and a reduction in surgery time.\*



\* Consultar las instrucciones de uso en formato electrónico.

1. Comprobar pegatina indicadora de diámetro y longitud del implante y abrir la pestaña de la caja de cartón.
2. Extraer el envase secundario y las etiquetas identificativas del producto.
3. Comprobar integridad del precinto de seguridad y desenroscar el tapón del envase secundario.
4. Extraer el envase primario del envase secundario evitando golpearlo contra una superficie rígida.
5. Extraer y guardar el tapón del envase primario, efectuando un movimiento lateral.
6. Introducir la llave-transportador HEX-3,00 mm hasta notar una ligera retención, encarando las marcas de la llave con las caras del hexágono del implante.
7. Comprobar que la llave está totalmente insertada y efectuar un pequeño giro mientras se estira con suavidad el conjunto.
8. Colocar el implante en el lecho óseo aplicando un par de 35 N-cm hasta que la parte tratada quede a nivel crestal o subcrestal. Extraer la llave.
9. Desatornillar el tornillo clínica y desmontar el transportador efectuando un pequeño giro si es necesario.
10. Extraer el tapón de cierre del tapón primario, utilizando la llave de HEX-0,80 mm para los tapones de cierre para plataforma Ø3,30 y la llave de HEX-1,20 mm para el resto de plataformas.
11. Roscar el tapón de cierre al implante aplicando un par máximo de 15 N-cm. Extraer llave y suturar incisión.

\* Consult the instructions for use in electronic format.

1. Check sticker indicating implant diameter and length and open the tab on the carton.
2. Remove the secondary packaging and product identification labels.
3. Check the integrity of the safety seal and unscrew the plug on the secondary packaging.
4. Remove the primary packaging from the secondary packaging avoiding hitting it against a hard surface.
5. Extract and save the primary packaging plug making a lateral movement.
6. Insert the HEX-3.00 mm implant carrier wrench until a slight retention is noticed, addressing the notches on the key with the faces of the implant hex broaching.
7. Check that the key is fully inserted and turn slightly while gently pulling on the assembly.
8. Place the implant in the bone bed by applying a torque of 35 N-cm until the treated area is at the crestal or subcrestal level. Remove the key.
9. Unscrew the clinic screw and dismount the implant carrier by turning slightly if necessary.
10. Remove the cover screw from the primary packaging plug, using the HEX-0.80 mm ratchet wrench for Ø3.30 platform and HEX-1.20 mm for the other platforms.
11. Screw the cover screw to the implant by applying a maximum torque of 15 N-cm. Remove key and suture incision.

## Gama de implantes gmi phoenix - gmi phoenix implants range

**Implantes phoenix de plataforma  $\varnothing$ 3,30 mm**  
 phoenix implants with  $\varnothing$ 3.30 mm platform

L (mm)	$\varnothing$ 3,30 mm
8,00	KDAoF0097
10,00	KDAoF0098
11,50	KDAoF0099
13,00	KDAoF0100
15,00	KDAoF0101

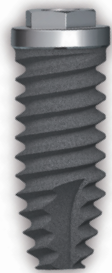
**Implantes phoenix de plataforma  $\varnothing$ 4,10 mm**  
 phoenix implants with  $\varnothing$ 4.10 mm platform

L (mm)	$\varnothing$ 3,30 mm	$\varnothing$ 3,75 mm	$\varnothing$ 4,00 mm
8,00	KDAoF0001	KDAoF0007	KDAoF0013
10,00	KDAoF0002	KDAoF0008	KDAoF0014
11,50	KDAoF0003	KDAoF0009	KDAoF0015
13,00	KDAoF0004	KDAoF0010	KDAoF0016
15,00	KDAoF0005	KDAoF0011	KDAoF0017
17,00	KDAoF0006	KDAoF0012	KDAoF0018

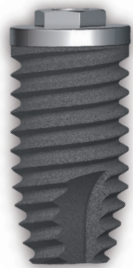
**Implantes phoenix de plataforma  $\varnothing$ 5,10 mm**  
 phoenix implants with  $\varnothing$ 5.10 mm platform

L (mm)	Hex. 2,70- $\varnothing$ 5,00 mm	Hex. 3,40- $\varnothing$ 5,00 mm
6,50	KDAoF0114	KDAoF0115
8,00	KDAoF0019	KDAoF0089
10,00	KDAoF0020	KDAoF0090
11,50	KDAoF0021	KDAoF0091
13,00	KDAoF0022	KDAoF0092

**Implantes phoenix de plataforma  $\varnothing$ 6,00 mm**  
 phoenix implants with  $\varnothing$ 6.00 mm platform

L (mm)	$\varnothing$ 6,00 mm
6,50	KDAoF0116
7,50	KDAoF0102
10,00	KDAoF0103

## Secuencias fresado para implantes gmi phoenix - Drilling sequences for gmi phoenix implants

A continuación se describen las secuencias de fresado para los diferentes modelos de implantes de conexión externa y las condiciones de corte aconsejadas para su uso:

- Fresa lanceolada: 1200 - 1500 rpm.
- Fresa piloto: 900 - 1200 rpm.
- Fresa guía: 800 rpm.
- Fresas finales:
  - $\varnothing 2,80$  mm  $\longrightarrow$  500 - 700 rpm.
  - $\varnothing 3,00$  y  $\varnothing 3,50$  mm  $\longrightarrow$  400 - 700 rpm.
  - $\varnothing 4,25$  mm  $\longrightarrow$  400 - 600 rpm.
  - $\varnothing 5,10$  y  $\varnothing 5,40$  mm  $\longrightarrow$  300 - 500 rpm.
- Para fresar es necesario disponer de refrigeración externa con solución salina.

Following is a description of the drilling sequences for the different external connection implant models, as well as the recommended drilling conditions for their use.

- Lance-shaped: 1200 - 1500 rpm
- Pilot drill: 900 - 1200 rpm
- Guide drill: 800 rpm
- Twist drills:
  - $\varnothing 2.80$  mm  $\longrightarrow$  500 - 700 rpm.
  - $\varnothing 3.00$  and  $\varnothing 3.50$  mm  $\longrightarrow$  400 - 700 rpm.
  - $\varnothing 4.25$  mm  $\longrightarrow$  400 - 600 rpm.
  - $\varnothing 5.10$  and  $\varnothing 5.40$  mm  $\longrightarrow$  300 - 500 rpm.
- For drilling, external cooling with saline solution is required.

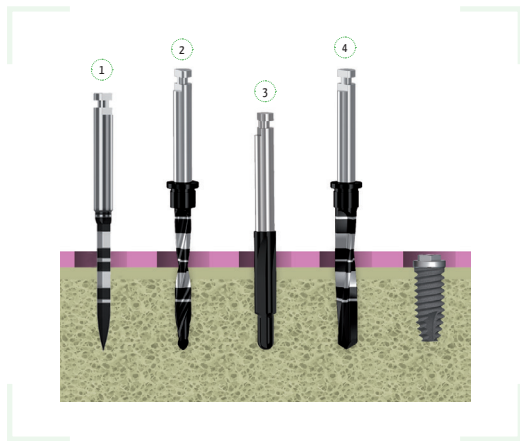

phoenix ø3,30		
	Descripción - Description	Ref.
1	Fresa lanceolada Lance-shaped drill	KYFoC1225
2	Fresa piloto Pilot drill	KYFoC2221
3	Fresa guía Guide drill	KYFoC3227
4	Fresa $\varnothing 2,80$ mm Twist drill $\varnothing 2.80$ mm	KYFoC0128

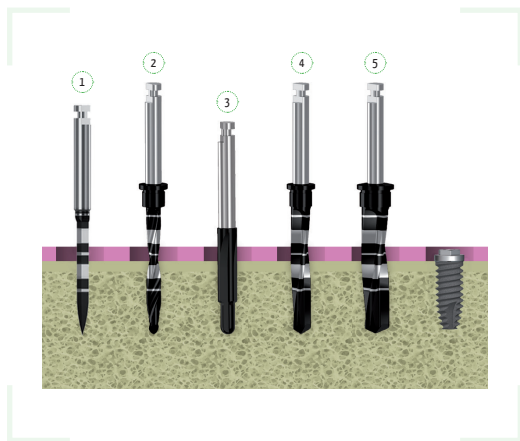

phoenix ø3,75		
	Descripción - Description	Ref.
1	Fresa lanceolada Lance-shaped drill	KYFoC1225
2	Fresa piloto Pilot drill	KYFoC2221
3	Fresa guía Guide drill	KYFoC3227
4	Fresa $\varnothing 2,80$ mm Twist drill $\varnothing 2.80$ mm	KYFoC0128
5	Fresa $\varnothing 3,25$ mm Twist drill $\varnothing 3.25$ mm	KYFoC0132

## Secuencias fresado para implantes gmi phoenix - Drilling sequences for gmi phoenix implants

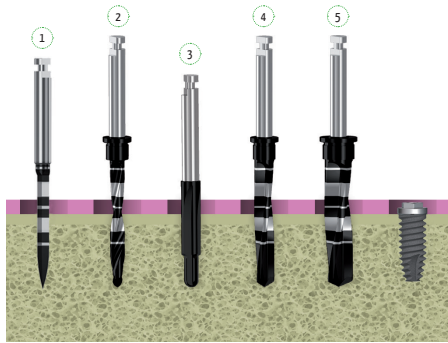

### phoenix $\varnothing 4,00$

	Descripción - Description	Ref.
1	Fresa lanceolada Lance-shaped drill	KYFOC1225
2	Fresa piloto Pilot drill	KYFOC2221
3	Fresa guía Guide drill	KYFOC3227
4	Fresa $\varnothing 2,80$ mm Twist drill $\varnothing 2.80$ mm	KYFOC0128
5	Fresa $\varnothing 3,50$ mm Twist drill $\varnothing 3.50$ mm	KYFOC0135

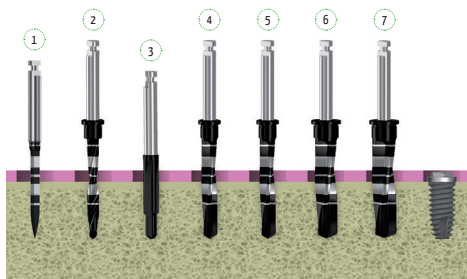

### phoenix $\varnothing 5,00$

	Descripción - Description	Ref.
1	Fresa lanceolada Lance-shaped drill	KYFOC1225
2	Fresa piloto Pilot drill	KYFOC2221
3	Fresa guía Guide drill	KYFOC3227
4	Fresa $\varnothing 2,80$ mm Twist drill $\varnothing 2.80$ mm	KYFOC0128
5	Fresa $\varnothing 3,00$ mm Twist drill $\varnothing 3.00$ mm	KYFOC0130
6	Fresa $\varnothing 3,50$ mm Twist drill $\varnothing 3.50$ mm	KYFOC0135
7	Fresa $\varnothing 4,25$ mm Twist drill $\varnothing 4.25$ mm	KYFOC0143

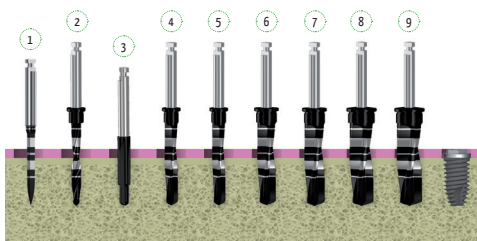

### phoenix $\varnothing 6,00$

	Descripción - Description	Ref.
1	Fresa lanceolada Lance-shaped drill	KYFOC1225
2	Fresa piloto Pilot drill	KYFOC2221
3	Fresa guía Guide drill	KYFOC3227
4	Fresa $\varnothing 2,80$ mm Twist drill $\varnothing 2.80$ mm	KYFOC0128
5	Fresa $\varnothing 3,00$ mm Twist drill $\varnothing 3.00$ mm	KYFOC0130
6	Fresa $\varnothing 3,50$ mm Twist drill $\varnothing 3.50$ mm	KYFOC0135
7	Fresa $\varnothing 4,25$ mm Twist drill $\varnothing 4.25$ mm	KYFOC0143
8	Fresa $\varnothing 5,10$ mm Twist drill $\varnothing 5.10$ mm	KYFOC0151
9	Fresa $\varnothing 5,40$ mm Twist drill $\varnothing 5.40$ mm	KYFOC0154

## Pilares de cicatrización gmi phoenix - gmi phoenix healing abutments

Una vez finalizada la fase de reparación de los tejidos de sostén del implante, en el caso de implantes cubiertos total o parcialmente por tejido blando, debe existir un canal o túnel mucoso que permita la conexión del implante a la estructura secundaria o prótesis. Los pilares de cicatrización son los encargados de formar esta vía mucosa una vez se ha abierto por incisión el tejido blando, se ha retirado el tapón de cierre y han sido roscados al implante.

### Características principales

- Mecanizados en titanio grado V según norma ISO-5832.
- Apriete con llave hexagonal de e/c 1,20 mm.
- Apriete alternativo con destornillador de punta plana.
- Disponibles en alturas de emergencia de 2,00 a 5,00 mm.
- Ligera conicidad de la cabeza para facilitar la extracción.
- Mecha apical para facilitar el inicio de roscado.

Once the repair phase of the tissue supporting the implant has finished, in the case of implants fully or partially covered by soft tissue there must be a mucosal channel or tunnel enabling connection of the implant to the prosthesis or secondary structure. Healing abutments are used to form the mucosal route, once the soft tissue has been opened by incision and the cover screw has been withdrawn, by screwing them to the implant.

### Key features

- Grade V titanium machining as per ISO-5832 standard.
- Tightening with b/f 1.20 mm hex wrench.
- Alternative tightening with a flat tip screwdriver.
- Available in emergency heights from 2.00 to 5.00 mm.
- Slightly tapered in the head to facilitate extraction.
- Apical bit to facilitate the start of threading.



### Pilares de cicatrización para plataforma $\varnothing 3,30$ mm Healing abutments for $\varnothing 3.30$ mm platform

Hex. impl.	Altura (mm) Height (mm)	Ref.
$\varnothing 2,40$ mm	2,00	KDPOC0023
	3,00	KDPOC0024
	4,00	KDPOC0025
	5,00	KDPOC0026



### Pilares de cicatrización para plataforma $\varnothing 4,10$ mm Healing abutments for $\varnothing 4.10$ mm platform

Hex. impl.	Altura (mm) Height (mm)	Ref.
$\varnothing 2,70$ mm	2,00	KDPOC0005
	3,00	KDPOC0006
	4,00	KDPOC0007
	5,00	KDPOC0008

## Pilares de cicatrización gmi phoenix - gmi phoenix healing abutments



### Pilares de cicatrización para plataforma $\varnothing 5,10$ mm Healing abutments for $\varnothing 5.10$ mm platform

Hex. impl.	Altura (mm) Height (mm)	Ref.
$\varnothing 2,70$ mm	2,00	KDPOC0011
	3,00	KDPOC0013
	4,00	KDPOC0015
	5,00	KDPOC0017
$\varnothing 3,40$ mm	2,00	KDPOC0012
	3,00	KDPOC0014
	4,00	KDPOC0016
	5,00	KDPOC0018



### Pilares de cicatrización para plataforma $\varnothing 6,00$ mm Healing abutments for $\varnothing 6.00$ mm platform

Hex. impl.	Altura (mm) Height (mm)	Ref.
$\varnothing 3,40$ mm	2,00	KDPOC0029
	3,00	KDPOC0030
	4,00	KDPOC0031
	5,00	KDPOC0032

## Pilares inclinados estéticos gmi phoenix - gmi phoenix esthetic angled abutments

Cuando es necesario corregir una posición angular extrema del implante en el interior de la estructura ósea, en relación a las piezas naturales o implantes adyacentes, se utilizarán los pilares inclinados que, una vez montados y orientados sobre el implante, permitirán la paralelización de la nueva corona con el resto de estructuras.

When it is necessary to correct an extreme angular position of the implant inside the bone structure in relation to adjacent natural or prosthetic teeth, angled abutments should be used. Once mounted and oriented on the implant, these abutments will allow the parallelization of the new crown with other structures.

### Características principales

- Mecanizados en titanio grado V según norma ISO-5832.
- Permiten corregir disparelismos de hasta 20 grados.
- Interior de 12 posiciones para una mayor flexibilidad.
- Tornillo clínica incluido.
- Hombro del pilar adaptado a la forma de la encía.

### Key features

- Grade V titanium machining as per ISO-5832 standard.
- Allow non-parallelism correction up to 20 degrees.
- 12-position interior for increased flexibility.
- Clinic screw included.
- Abutment shoulder adapted to the shape of the gum.



### Pilares inclinados estéticos para plataforma ø3,30 mm Esthetic angled abutments for ø3.30 mm platform

Hex. impl.	Tipo conexión Connection type	Ang. (°)	Ref.
○ 2,40 mm	Antir. • Non-rot.	15°	KDMoF0060
	Antir. • Non-rot.	20°	KDMoF0069

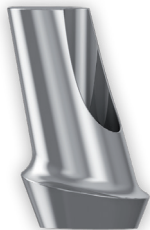

### Pilares inclinados estéticos para plataforma ø4,10 mm Esthetic angled abutments for ø4.10 mm platform

Hex. impl.	Tipo conexión Connection type	Ang. (°)	Ref.
○ 2,70 mm	Antir. • Non-rot.	15°	KDMoF0002
	Antir. • Non-rot.	20°	KDMoF0070



### Pilares inclinados estéticos para plataforma ø5,10 mm Esthetic angled abutments for ø5.10 mm platform

Hex. impl.	Tipo conexión Connection type	Ang. (°)	Ref.
○ 2,70 mm	Antir. • Non-rot.	15°	KDMoF0008
	Antir. • Non-rot.	20°	KDMoF0071
○ 3,40 mm	Antir. • Non-rot.	15°	KDMoF0014
	Antir. • Non-rot.	20°	KDMoF0072

## Pilares rectos gmi phoenix - gmi phoenix straight abutments

Una vez formado el túnel mucoso por el pilar de cicatrización y retirado este de su localización, se procede a utilizar el pilar correspondiente, que se define como el aditamento mecanizado cónico que una vez fijado con el tornillo clínica a la parte superior del implante sirve de soporte para la corona clínica fijándose a ésta mediante la utilización de cemento.

### Características principales

- Mecanizados en titanio grado V según norma ISO-5832.
- Planos anti-rotatorios para facilitar la retención.
- Pilares rectos en versión anti-rotatoria hexagonal.
- Tornillo clínica incluido.

Once the mucosal tunnel has been formed by the healing abutment and after removing it from this location, it is appropriate to use the abutment, which is defined as the machined tapered attachment that, after being fixed with the clinic screw to the top of the implant, acts as a support for the clinic crown and is attached to it using cement.

### Key features

- Grade V titanium machining as per ISO-5832 standard.
- Anti-rotational planes to increase retention.
- Straight abutments in hex non-rotary version.
- Clinic screw included.



### Pilares rectos para plataforma ø3,30 mm Straight abutments for ø3.30 mm platform

Hex. impl.

Ref.

○ 2,40 mm

KDMoF0058



### Pilares rectos para plataforma ø4,10 mm Straight abutments for ø4.10 mm platform

Hex. impl.

Ref.

○ 2,70 mm

KDMoF0034



### Pilares rectos para plataforma ø5,10 mm Straight abutments for ø5.10 mm platform

Hex. impl.

Ref.

○ 2,70 mm

KDMoF0035

○ 3,40 mm

KDMoF0036



## Pilares rectos gmi phoenix - gmi phoenix straight abutments



### Pilares rectos para plataforma $\varnothing 6,00$ mm Straight abutments for $\varnothing 6.00$ mm platform

Hex. impl.	Ref.
$\varnothing 3,40$ mm	KDMoF0062

## Pilares transportador gmi phoenix - gmi phoenix implant carrier abutments

Cuando sea necesario utilizar un pilar a medida se utilizarán los pilares transportador, que permitirán, mediante el corte en cualquier dirección, adecuarse a las necesidades del protésico. Además y como función complementaria, los pilares transportador fresables pueden ser utilizados como toma de impresión, roscándolos al implante mediante el tornillo de impresión corto y utilizándolos para hacer el negativo de la boca del paciente y su posterior positivación en escayola.

When the use of a custom abutment is required, carrier abutments can be used. By cutting them in any direction, they can be suited to the needs of the prosthetic. In addition and as a complementary function, millable transfer abutments can be used like impression coping, threading them to the implant screw through the short impression screw and using them to make the negative of the patient's mouth for subsequent positivation on plaster.

### Características principales

- Mecanizados en titanio grado V según norma ISO-5832.
- Permiten corte en cualquier dirección adecuándose a las necesidades protésicas.
- Compatibles con llave hexagonal de e/c 4,00 mm para utilizar como transportador.
- Disponibles sólo en versión anti-rotatoria.
- Posibilidad de utilizarlos como toma de impresión con tornillo impresión corto.
- Tornillo clínica incluido.

### Key features

- Grade V titanium machining as per ISO-5832 standard.
- They allow cutting in any direction to suit the needs of the prosthetic.
- Compatible with b/f 4.00 mm hex wrench for use as an implant carrier.
- Available only in non-rotary version.
- Possibility to use as impression coping with short impression screw.
- Clinic screw included.



### Pilares transportador para plataformas $\varnothing 3,30 / 4,10 / 5,10 / 6,00$ mm Implant carrier abutments for $\varnothing 3.30 / 4.10 / 5.10 / 6.00$ mm platforms

Hex. impl.	Plataforma Platform	Ref.
$\varnothing 2,40$ mm	$\varnothing 3.30$	KDBoF0004
$\varnothing 2,70$ mm	$\varnothing 4.10$	KDBoF0001
	$\varnothing 5.10$	KDBoF0002
$\varnothing 3,40$ mm	$\varnothing 5.10$	KDBoF0003
	$\varnothing 6.00$	KDBoF0005

## Pilares bola gmi phoenix - gmi phoenix ball abutments

Una vez formado el túnel mucoso por el pilar de cicatrización, y retirado este de su localización, se procede a utilizar el pilar bola correspondiente, que se define como el aditamento mecanizado que una vez fijado a la parte superior del implante sirve de elemento retentivo de la prótesis removible, la cual lleva incorporados previamente los casquillos de retención que se fijarán en la parte esférica superior de los pilares bola.

### Características principales

- Mecanizados en titanio grado V según norma ISO-5832.
- Disponibles en alturas de emergencia de 1,50 a 3,00 mm.
- Cofia de retención rosa y contenedor incluidos.
- Disco de protección incluido.
- Apriete con llave hexagonal de e/c 2,45 mm ref: KYLOCO065.
- Instrumental para cofias: Insertador / extractor de cofias (RH485IC).

Once the healing abutment has formed the mucosal tunnel and the healing abutment has been removed from this location, the corresponding ball abutment is used, which is defined as a machined attachment being fixed to the top of the implant and serving as the retention element for the removable prosthesis, with the previous addition of the retention caps that will be fixed to the top spherical part of the ball abutment.

### Key features

- Grade V titanium machining as per ISO-5832 standard.
- Available in emergency heights from 1.50 to 3.00 mm.
- Pink retention cap and metal container included.
- Protection disk included.
- Tightening with b/f 2.45 mm hex wrench, part no.: KYLOCO065.
- Instruments for caps: Insertion / removal tool for caps (RH485IC).



### Pilares bola para plataforma $\varnothing 4,10$ mm Ball abutment for $\varnothing 4.10$ mm platform

Hex. impl.	Altura (mm) Height (mm)	Ref.
$\varnothing 2,70$ mm	3,00	KDFoF0045
	2,50	KDFoF0046
	2,00	KDFoF0047
	1,50	KDFoF0048

### Pilares bola para plataforma $\varnothing 5,10$ mm Ball abutment for $\varnothing 5.10$ mm platform

Hex. impl.	Altura (mm) Height (mm)	Ref.
$\varnothing 3,40$ mm	3,00	KDFoF0049
	2,50	KDFoF0050
	2,00	KDFoF0051
	1,50	KDFoF0052
$\varnothing 2,70$ mm	3,00	KDFoF0053
	2,50	KDFoF0054
	2,00	KDFoF0055
	1,50	KDFoF0056

## Pilares bola gmi phoenix - gmi phoenix ball abutments



Retenciones Retention caps			
Tipo retención Retainer type	Color	Cantidad (ud.) Quantity (un.)	Ref.
Suave • Soft (900 gr)	Rosa • Pink	6	RH40CRNSN
Fuerte • Strong (1300 gr)	Verde • Green	6	RH040CRN
Elástica • Elastic (500 gr)	Naranja • Orange	6	RH049PCN



Contenedor cofias Metal container	
Cantidad (ud.) Quantity (un.)	Ref.
2	RH041CANB



Discos protección Protection disks	
Cantidad (ud.) Quantity (un.)	Ref.
10	RH100PD

## Pilares multi-estético gmi phoenix - gmi phoenix multi-esthetic abutments

Una vez efectuada la primera etapa de la cirugía, y por tanto obtenida la osteointegración del implante, se procede a utilizar el pilar multi-estético (PME), que se define como el aditamento mecanizado que una vez fijado a la parte coronal del implante sirve como soporte de una restauración múltiple, disminuyendo la altura entre la conexión del implante y la conexión de la estructura, y facilitando el ajuste pasivo de la estructura.

### Características principales

- Mecanizados en titanio grado V según norma ISO-5832.
- Disponibles en alturas de emergencia de 1,50 a 4,50 mm.
- Pilares rectos de una sola pieza en versión rotatoria.
- Apriete con llaves hexagonales:  
 PL-Ø3,30 y Ø4,10: E/C 2,00 mm (KYLOCo149)  
 PL-Ø5,10: E/C 2,50 mm (KYLOCo098)
- Toma de impresión con tornillo incluido.
- Calcinable con tornillo clínica incluido.
- Cilindro provisional en titanio grado V según ISO-5832, con tornillo clínica incluido.
- Los PME inclinados permiten corregir disparelismos de hasta 30°.

Following the first stage of surgery and therefore after implant osseointegration is achieved, the multi-esthetic abutment (MEA) is used, that is defined as the machined attachment that, after being attached to the crown of the implant, serves as a support for a multiple restoration, thus decreasing the height between the implant connection and the structure connection, and providing a passive adjustment of the structure.

### Key features

- Grade V titanium machining as per ISO-5832 standard.
- Available in emergency heights from 1.50 to 4.50 mm.
- One-piece straight abutments in rotary model.
- Tightened with hex keys:  
 PL-Ø3.30 and Ø4.10: B/F 2.00 mm (KYLOCo149)  
 PL-Ø5.10: B/F 2.50 mm (KYLOCo098)
- Impression coping with screw included.
- Castable with clinic screw included.
- Temporary cylinder in grade V titanium with clinic screw included.
- Angled multi-esthetic abutments allow non-parallelism up to 30°.



### Pilares multi-estético inclinados para plataformas Ø3,30 / Ø4,10 mm Angled MEA for Ø3.30 / Ø4.10 mm platforms

Plataforma Platform	Hex. impl.	Ang. (°)	Altura (mm) Height (mm)	Ref.
Ø3,30	⊙ 2,40 mm	17°	2,50	KDGoF0030
		17°	2,50	KDGoF0031
Ø4,10	⊙ 2,70 mm	17°	3,50	KDGoF0032
		30°	4,50	KDGoF0033



### Pilares multi-estético rectos para plataforma Ø3,30 mm Straight MEA for Ø3.30 mm platform

Hex. impl.	Altura (mm) Height (mm)	Ref.
⊙ 2,40 mm	1,50	KDGoC0016
	2,50	KDGoC0017
	3,50	KDGoC0018
	4,50	KDGoC0019

## Pilares multi-estético gmi phoenix - gmi phoenix multi-esthetic abutments



### Pilares multi-estético rectos para plataforma $\varnothing 4,10$ mm Straight MEA for $\varnothing 4.10$ mm platform

Hex. impl.	Altura (mm) Height (mm)	Ref.
$\varnothing 2,70$ mm	1,50	KDGoC0012
	2,50	KDGoC0013
	3,50	KDGoC0014
	4,50	KDGoC0015



### Pilares multi-estético rectos para plataforma $\varnothing 5,10$ mm Straight MEA for $\varnothing 5.10$ mm platform

Hex. impl.	Altura (mm) Height (mm)	Ref.
$\varnothing 2,70$ mm	1,50	KDGoC0020
	2,50	KDGoC0021
	3,50	KDGoC0022
	4,50	KDGoC0023
$\varnothing 3,40$ mm	1,50	KDGoC0024
	2,50	KDGoC0025
	3,50	KDGoC0026
	4,50	KDGoC0027



### Pilares cicatrización PME Healing abutments MEA

Plataforma Platform	$\varnothing$ Diámetro $\varnothing$ Diameter	Ref.
$\varnothing 4,80$	$\varnothing 4,80$	KDPoF0035
	$\varnothing 6,00$	KDPoF0037
$\varnothing 6,00$	$\varnothing 6,00$	KDPoF0036



### Tomas impresión cubeta abierta (CA) larga PME Open tray (OT) long impression coping MEA

Plataforma Platform	Ref.
$\varnothing 4,80$	KDSoF0015
$\varnothing 6,00$	KDSoF0016

## Pilares multi-estético gmi phoenix - gmi phoenix multi-esthetic abutments

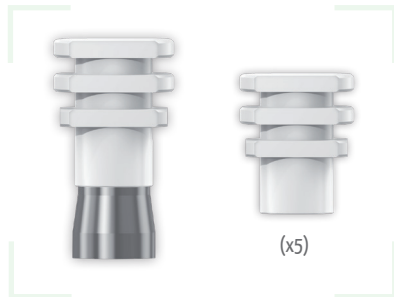

Toma impresión cubeta cerrada (CC) PME Closed tray (CT) impression coping MEA		
Plataforma Platform	Cantidad (Ud.) Quantity (Un.)	Ref.
ø4,80	1	KDS0F0017
	5	KDS0F5001

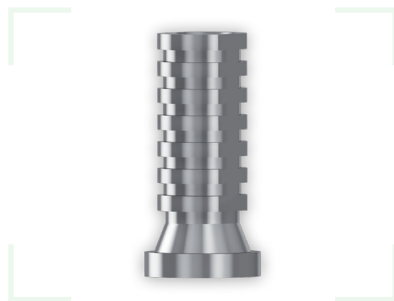

Cilindros provisionales PME Temporary cylinders MEA	
Plataforma Platform	Ref.
ø4,80	KDGoF0028
ø6,00	KDGoF0029



Calcinables PME Castables MEA	
Plataforma Platform	Ref.
ø4,80	KDCoF0117
ø6,00	KDCoF0118



Base titanio PME Titanium base MEA	
Plataforma Platform	Ref.
ø4,80	KDGoF0035
ø6,00	KDGoF0036

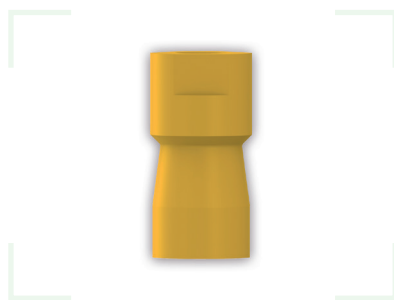

Scanbody de titanio PME Titanium scanbody MEA	
Plataforma Platform	Ref.
ø4,80	KDioF0002
ø6,00	KDioF0003

## Réplicas gmi phoenix - gmi phoenix replicas

Una vez realizada la transferencia de la posición mediante la toma de impresión del medio biológico al modelo de trabajo de laboratorio, es necesario utilizar las réplicas, que se definen como el aditamento mecanizado destinado por una parte a reproducir la posición del implante en la boca del paciente a un modelo de trabajo y por otra a servir de modelo de conexión para la construcción en el laboratorio de la estructura destinada a efectuar la restauración.

### Características principales

- Mecanizadas en titanio grado V según norma ISO-5832.
- Fresados anti-giro y cuello de retención vertical para una buena fijación.

Once the transfer of the position has been made using the impression coping from the biological medium to the laboratory working model, it is necessary to use replicas, which are defined as the machined attachments designed on one hand to reproduce the implant position in the mouth of the patient to a working model, and on the other to serve as a connection model for the construction in the laboratory of the structure to carry out the restoration.

### Key features

- Grade V titanium machining as per ISO-5832 standard.
- Anti-rotation millings and vertical retention neck for a good fixation.



### Réplicas de implante para plataformas $\varnothing 3,30$ / $4,10$ / $5,10$ / $6,00$ mm Implant replicas for $\varnothing 3.30$ / $4.10$ / $5.10$ / $6.00$ mm platforms

Hex. impl.	Plataforma (mm) Platform (mm)	Ref.
$\varnothing 2,40$ mm	$\varnothing 3,30$	KDRoC0010
$\varnothing 2,70$ mm	$\varnothing 4,10$	KDRoC0002
	$\varnothing 5,10$	KDRoC0006
$\varnothing 3,40$ mm	$\varnothing 5,10$	KDRoC0008
	$\varnothing 6,00$	KDRoC0011

### Réplicas para pilar multi-estético MEA replicas

Plataforma Platform	Ref.
$\varnothing 4,80$	KDRoC0012
$\varnothing 6,00$	KDRoC0013

### Réplicas digitales para pilar multi-estético MEA digital replicas

Plataforma Platform	Ref.
$\varnothing 4,80$	KDRoF0014
$\varnothing 6,00$	KDRoF0015

## Tomas de impresión gmi phoenix - gmi phoenix impression coping

Las tomas de impresión se definen como el aditamento mecanizado que conexasiónado a la parte coronal del implante en el interior de la cavidad bucal, y fijado axialmente mediante el tornillo de impresión, sirve para realizar la transferencia de la posición del implante en el medio biológico a un modelo de laboratorio, sobre el cual trabajará el protésico para crear las coronas o prótesis dentales. Este proceso se consigue utilizando materiales de impresión que colocados de forma apropiada, se endurecen en la cavidad bucal permitiendo la obtención del negativo de la boca del paciente. Una vez extraído, se colocan las réplicas y se efectúa el vaciado de escayola para obtener el molde positivo donde la réplica quedará en la posición original del implante en boca.

### Características principales

- Toma impresión CA mecanizada en titanio grado V según norma ISO-5832.
- Tornillos de impresión mecanizados en titanio grado V según norma ISO-5832.
- Apriete tornillos impresión con llave hexagonal de e/c 1,20 mm.
- Mecha apical para facilitar el inicio de roscado.
- Fresados anti-giro y cuello de retención vertical para una buena fijación.
- Tornillos de toma de impresión incluidos.
- Tornillo largo con fresados longitudinales para apriete manual.
- Toma de impresión CC mecanizada en plástico técnico.

Impression coping are defined as the machined attachments that, connecting to the coronal part of the implant within the oral cavity and axially fixed by the impression screw, are used to make the transfer of the position of the implant in the biological medium to a laboratory model, on which the prosthetic will work to create the dental crowns or prostheses. This process is achieved using impression materials placed in an appropriate manner, that will harden in the oral cavity and produce the negative of the patient's mouth. Once extracted, replicas are placed and the casting plaster is poured to obtain the positive mould where the replica will be placed in the original position of the implant in the mouth.

### Key features

- Machined open tray impression coping in grade V titanium according to ISO-5832.
- Impression screws in grade V titanium according to ISO-5832.
- Tightening of impression screws with b/f 1.20 mm hex wrench.
- Apical bit to facilitate the start of threading.
- Anti-rotation millings and vertical retention neck for a good fixation.
- Impression coping screw included.
- Long impression screw with longitudinal millings for manual tightening.
- CT impression coping machined in technical plastic.



### Tomas impresión cubeta abierta (CA) plataforma Ø3,30 mm Open tray (OT) impression coping for Ø3.30 mm platform

Hex. impl.	Tornillo Screw	Ref.
○ 2,40 mm	Largo • Long	KDS0F0007
	Corto • Short	KDS0F0012



### Tomas impresión cubeta abierta (CA) plataforma Ø4,10 mm Open tray (OT) impression coping for Ø4.10 mm platform

Hex. impl.	Tornillo Screw	Ref.
○ 2,70 mm	Largo • Long	KDS0F0002
	Corto • Short	KDS0F0009



## Tomas de impresión gmi phoenix - gmi phoenix impression coping



**Tomas impresión cubeta abierta (CA) plataforma  $\varnothing 5,10$  mm**  
 Open tray (OT) impression coping for  $\varnothing 5.10$  mm platform

Hex. impl.	Tornillo Screw	Ref.
$\varnothing 2,70$ mm	Largo • Long	KDS0F0004
	Corto • Short	KDS0F0010
$\varnothing 3,40$ mm	Largo • Long	KDS0F0006
	Corto • Short	KDS0F0011



**Tomas impresión cubeta abierta (CA) plataforma  $\varnothing 6,00$  mm**  
 Open tray (OT) impression coping for  $\varnothing 6.00$  mm platform

Hex. impl.	Tornillo Screw	Ref.
$\varnothing 3,40$ mm	Largo • Long	KDS0F0008
	Corto • Short	KDS0F0013



**Tomas impresión cubeta cerrada (CC)**  
 Closed tray (CT) impression coping

Cantidad (Ud.) Quantity (Un.)	Ref.
5	KDS0F0014

## Calcinables gmi phoenix - gmi phoenix castables

Para sustituir una corona dental con una prótesis de restauración se utiliza el calcinable, que se define como el aditamento mecanizado de plástico fundible que una vez posicionado sobre la parte coronal del implante de conexión externa servirá de base inicial para modelar la forma que tendrá la estructura final, que será colada en el metal correspondiente.

### Características principales

- Calcinables mecanizados en material plástico fundible de color blanco.
- Fisiológicamente inertes y excelente estabilidad dimensional.
- Disponibles en versión rotatoria y anti-rotatoria.

To replace a dental crown with a restoration dental prosthesis, a castable is used, which is defined as a meltable plastic machined attachment that, once positioned over the coronal part of the external connection implant, will be the initial basis to model the form of the final structure, to be cast in the corresponding metal.

### Key features

- Machined castables in white meltable plastic material.
- Physiologically inert and excellent dimensional stability.
- Available in rotary and non-rotary version.



### Calcinables para plataforma $\varnothing 3,30$ mm Castables for $\varnothing 3.30$ mm platform

Hex. Impl.	Tipo conexión Connection type	Ref.
$\varnothing 2,40$ mm	Anti-rotatoria • Non-rotary	KDCoF0115
	Rotatoria • Rotary	KDCoF0116

### Calcinables para plataforma $\varnothing 4,10$ mm Castables for $\varnothing 4.10$ mm platform

Hex. Impl.	Tipo conexión Connection type	Ref.
$\varnothing 2,70$ mm	Anti-rotatoria • Non-rotary	KDCoF0101
	Rotatoria • Rotary	KDCoF0105

## Calcinables gmi phoenix - gmi phoenix castables



### Calcinables para plataforma $\varnothing 5,10$ mm Castables for $\varnothing 5.10$ mm platform

Hex. Impl.	Tipo conexión Connection type	Ref.
$\varnothing$ 2,70 mm	Anti-rotatoria • Non-rotary	KDCoFo102
	Rotatoria • Rotary	KDCoFo104
$\varnothing$ 3,40 mm	Anti-rotatoria • Non-rotary	KDCoFo108
	Rotatoria • Rotary	KDCoFo109

### Calcinables para plataforma $\varnothing 6,00$ mm Castables for $\varnothing 6.00$ mm platform

Hex. Impl.	Tipo conexión Connection type	Ref.
$\varnothing$ 3,40 mm	Anti-rotatoria • Non-rotary	KDCoFo103
	Rotatoria • Rotary	KDCoFo110

## Tornillos clínica y laboratorio gmi phoenix - gmi phoenix clinic and laboratory screws

Los tornillos clínica se definen como los aditamentos mecanizados utilizados para el anclaje definitivo de los pilares, el transportador o el calcinable directo al implante, mientras que los tornillos de laboratorio son los aditamentos mecanizados utilizados para el anclaje provisional de los calcinables a la réplica del implante, utilizados por el protésico en el laboratorio donde se construyen las coronas dentales o prótesis.

### Características principales

- Tornillos mecanizados en titanio grado V según norma ISO-5832.
- Apriete tornillos con llave hexagonal de e/c 1,20 mm.
- Mecha apical para facilitar el inicio de roscado.

Clinic screws are defined as machined devices used for the final anchoring of the abutments, the transfer or the castable directly to the implant, while laboratory screws are the machined devices used for the temporary anchoring of castables to the replica of the implant used by the dental laboratory where the construction of dental crowns or prostheses takes place.

### Key features

- Machined grade V titanium screws according to ISO-5832.
- Tightening of screws with b/f 1.20 mm hex wrench.
- Apical bit to facilitate the start of threading.



### Tornillos clínica Clinic screws

Hex. llave (mm) Hex. wrench (mm)	Rosca (mm) Thread (mm)	Ref.
⊙ 1,20 mm	M2,0x0,40	KDToC0030
	M2,5x0,45	KDToC0037
	M1,8x0,35	KDToC0045

### Tornillos laboratorio Laboratory screws

Hex. llave (mm) Hex. wrench (mm)	Rosca (mm) Thread (mm)	Ref.
⊙ 1,20 mm	M2,0x0,40	KDToC0004
	M2,5x0,45	KDToC0038
	M1,8x0,35	KDToC0050

## Tornillos PME gmi phoenix - gmi phoenix MEA screws

Los tornillos para PME se definen como los aditamentos mecanizados utilizados para el anclaje definitivo de los aditamentos multi-estéticos.

MEA screws are defined as machined devices used for the final anchoring of the multi-esthetic abutments.

### Características principales

### Key features

- Tornillos mecanizados en titanio grado V según norma ISO-5832.
- Apriete tornillos con llave hexagonal de e/c 1,20 mm.

- Machined grade V titanium screws according to ISO-5832.
- Tightening of screws with b/f 1.20 mm hex wrench.



Tornillos PME MEA screws	
Plataforma Platform	Ref.
ø4,80	KDToC0056
ø6,00	KDToC0060

Tornillos laboratorio PME MEA laboratory screws	
Plataforma Platform	Ref.
ø4,80	KDToC0057
ø6,00	KDToC0058

## Pares recomendados de apriete - Recommended tightening torques

Par máximo inserción implante • Implant insertion maximum torque



Apriete tapones de cierre y pilares de cicatrización • Healing abutments and cover screw tightening torque



Apriete tornillos clínica • Clinic screw tightening torque



Apriete pilares bola • Ball abutments tightening torque



Apriete pilares multi-estético rectos • Multi-esthetic straight abutments tightening torque



Apriete tornillos multi-estético • Multi-esthetic screw tightening torque



Apriete tornillo impresión • Impression coping screw tightening torque



Apriete pilares multi-estético inclinado • Angled multi-esthetic abutments tightening torque



## Kit quirúrgico gmi phoenix - gmi phoenix surgical kit

El kit quirúrgico **gmi phoenix** está formado por una caja autoclavable fabricada en resina técnica de alta resistencia, que contiene todo el material necesario para la correcta colocación del sistemas de implantes dentales de conexión externa **gmi phoenix**. Los componentes se encuentran dispuestos de tal manera que sea sencillo encontrar en cada momento el instrumento necesario para cada fase de la intervención.

Los kits quirúrgicos gmi se distribuyen en cajas confeccionadas en polímero técnico de alta resistencia y deben esterilizarse en autoclave de calor húmedo antes de su uso a una temperatura máxima de 134°C.

**gmi phoenix surgical kit** consists of an autoclavable case made of high strength resin, containing all the necessary material for the correct positioning of **gmi phoenix** external connection dental implant system. The components are arranged in such a way to be easy to find in each moment and in any stage of the intervention.

**gmi surgical kits** are distributed in cartons, made of high strength technical polymer, and should be steam autoclaved before use at a maximum temperature of 134°C.



	Descr.	Un.	Ref.
Fresa lanceolada	Lance-shaped drill	1	KYFoC1225
Fresa piloto ø2,00 mm	Pilot drill ø2.00 mm	1	KYFoC2221
Fresa guía ø2,00 / ø2,70 mm	Guide drill ø2.00 / ø2.70 mm	1	KYFoC3227
Fresa final ø2,80 mm	Twist drill ø2.80 mm	1	KYFoC0128
Fresa final ø3,00 mm	Twist drill ø3.00 mm	1	KYFoC0130
Fresa final ø3,25 mm	Twist drill ø3.25 mm	1	KYFoC0132
Fresa final ø3,50 mm	Twist drill ø3.50 mm	1	KYFoC0135
Fresa final ø4,25 mm	Twist drill ø4.25 mm	1	KYFoC0143
Fresa final ø5,10 mm	Twist drill ø5.10 mm	1	KYFoC0151
Fresa final ø5,40 mm	Twist drill ø5.40 mm	1	KYFoC0154
Llave transportador plana 45°	Manual wrench 45°	1	KYLoC0093
Llave carraca IP	TI ratchet wrench	1	KYLoF0113
Llave-transportador HEX - 3,00 mm IP corta	Short HEX-3.00 mm implant carrier TI wrench	1	KYLoF0123
Llave-transportador HEX - 3,00 mm IP larga	Long HEX-3.00 mm implant carrier TI wrench	1	KYLoF0124
Llave-transportador HEX - 3,00 mm CA	HEX-3.00 mm implant carrier HP wrench	1	KYLoF0122
Llave fija HEX - 1,20 mm manual	HEX-1.20 mm fixed manual wrench	1	KYLoC0011
Llave carraca corta HEX - 1,20 mm	Short HEX-1.20 mm ratchet wrench	1	KYLoF0128
Llave carraca larga HEX - 1,20 mm	Long HEX-1.20 mm ratchet wrench	1	KYLoF0129
Llave fija HEX - 0,80 mm manual	HEX-0.80 mm fixed manual wrench	1	KYLoC0092
Alargador fresas	Drill extender	1	KYLoC0023
Paralelizador ø2,00 / ø2,80 mm	Paralleling pin ø2.00 / ø2.80 mm	3	KYLoC0078
Indicador profundidad ø2,80 mm	Depth gauge ø2.80 mm	1	KYLoC0094
Indicador profundidad ø3,50 mm	Depth gauge ø3.50 mm	1	KYLoC0095

## Especificaciones técnicas - Technical specifications

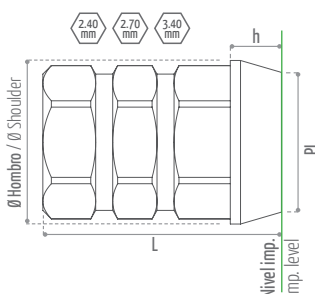
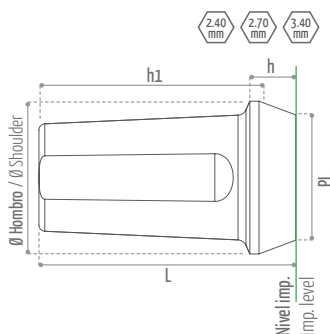
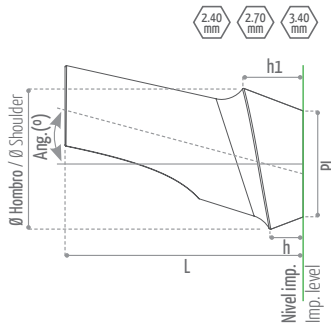
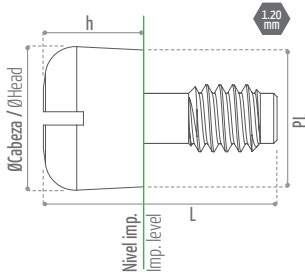

### Pilares de cicatrización - Healing abutments (mm)

Referencia - Reference	L	h	Ø Cabeza - Ø Head	Hex.	Plataforma - Platform
KDPoC0023	6,30	2,00			
KDPoC0024	7,00	3,00	Ø 3,50	2,40	Ø 3,30
KDPoC0025	8,00	4,00			
KDPoC0026	9,00	5,00			
KDPoC0005	6,00	2,00	Ø 4,30	2,70	Ø 4,10
KDPoC0006	7,00	3,00			
KDPoC0007	8,00	4,00	Ø 5,30	2,70	Ø 5,10
KDPoC0008	9,00	5,00			
KDPoC0011	6,00	2,00			
KDPoC0013	7,00	3,00	Ø 5,30	3,40	Ø 6,00
KDPoC0015	8,00	4,00			
KDPoC0017	9,00	5,00			
KDPoC0012	6,00	2,00	Ø 6,20	3,40	Ø 6,00
KDPoC0014	7,00	3,00			
KDPoC0016	8,00	4,00			
KDPoC0018	9,00	5,00			
KDPoC0029	6,00	2,00			
KDPoC0030	7,00	3,00			
KDPoC0031	8,00	4,00			
KDPoC0032	9,00	5,00			

### Pilares inclinados estéticos - Esthetic angled abutments (mm)

Referencia - Reference	L	h	h1	Ang. (°)	Ø Hombro - Ø Shoulder	Hex.	Plataforma - Platform
KDMoF0060	9,20	1,50	2,30	15°	4,60	2,40	Ø 3,30
KDMoF0069	9,20	1,50	2,30	20°	4,60		
KDMoF0002	9,20	1,30	2,30	15°	5,40	2,70	Ø 4,10
KDMoF0070	9,20	1,30	2,50	20°	5,40		
KDMoF0008	9,20	1,20	2,60	15°	6,40	2,70	Ø 5,10
KDMoF0071	9,20	1,20	2,50	20°	6,40		
KDMoF0014	9,20	1,20	2,60	15°	6,40	3,40	Ø 6,00
KDMoF0072	9,20	1,20	2,50	20°	6,40		

### Pilares rectos - Straight abutments (mm)

Referencia - Reference	L	h	h1	Ø Hombro - Ø Shoulder	Hex.	Plataforma - Platform
KDMoF0058	8,40	1,50	6,70	Ø 4,20	2,40	Ø 3,30
KDMoF0034	8,40	1,50	6,70	Ø 5,00	2,70	Ø 4,10
KDMoF0035	8,40	1,50	6,70	Ø 6,00	2,70	Ø 5,10
KDMoF0036	8,40	1,50	6,70	Ø 6,00	3,40	Ø 6,00
KDMoF0062	8,40	1,50	6,70	Ø 7,00	3,40	Ø 6,00

### Pilares fresables - Millable abutments (mm)

Referencia - Reference	L	h	Ø Hombro - Ø Shoulder	Hex.	Plataforma - platform
KDBoF0004	7,00	1,50	Ø 4,50	2,40	Ø 3,30
KDBoF0001	7,00	1,50	Ø 4,80	2,70	Ø 4,10
KDBoF0002	7,00	1,50	Ø 5,80	2,70	Ø 5,10
KDBoF0003	7,00	1,50	Ø 5,80	3,40	Ø 5,10
KDBoF0005	7,00	1,50	Ø 6,70	3,40	Ø 6,00



## Especificaciones técnicas - Technical specifications

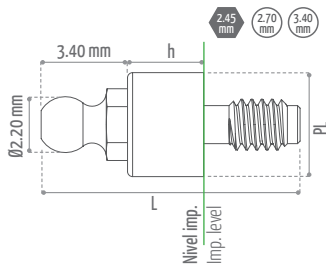

Pilares bola - Ball abutments (mm)				
Referencia - Reference	L	h	Hex.	Plataforma - Platform
KDFoF0045	10,20	3,00		
KDFoF0046	9,70	2,50		
KDFoF0047	9,20	2,00	2,70	Ø 4,10
KDFoF0048	8,70	1,50		
KDFoF0049	10,20	3,00		
KDFoF0050	9,70	2,50	3,40	
KDFoF0051	9,20	2,00		
KDFoF0052	8,70	1,50		
KDFoF0053	10,20	3,00		Ø 5,10
KDFoF0054	9,70	2,50		
KDFoF0055	9,20	2,00	2,70	
KDFoF0056	8,70	1,50		

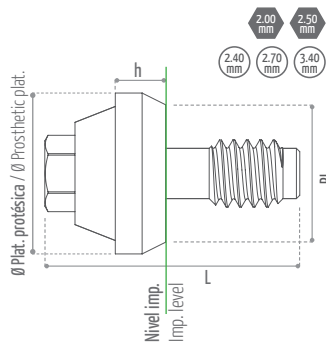

Pilares multi-estético rectos - Multi-esthetic straight abutments (mm)					
Referencia - Reference	L	h	Ø Plat. protésica - Ø Prosthetic plat.	Hex.	Plataforma - Platform
KDGoC0016	7,60	1,50			
KDGoC0017	8,60	2,50			
KDGoC0018	9,60	3,50	Ø 4,80	2,40	Ø 3,30
KDGoC0019	10,60	4,50			
KDGoC0012	7,60	1,50			
KDGoC0013	8,60	2,50			
KDGoC0014	9,60	3,50	Ø 4,80	2,70	Ø 4,10
KDGoC0015	10,60	4,50			
KDGoC0020	7,60	1,50			
KDGoC0021	8,60	2,50			
KDGoC0022	9,60	3,50	Ø 6,00	2,70	
KDGoC0023	10,60	4,50			
KDGoC0024	7,60	1,50			Ø 5,10
KDGoC0025	8,60	2,50			
KDGoC0026	9,60	3,50	Ø 6,00	3,40	
KDGoC0027	10,60	4,50			

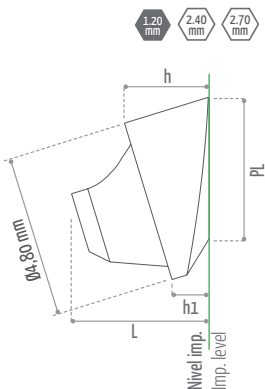

Pilares multi-estético inclinados - Multi-esthetic angled abutments (mm)						
Referencia - Reference	Ang. (°)	L	h	h1	Hex.	Plataforma - Platform
KDGoF0030	17°	4,30	2,50	1,10	2,40	Ø 3,30
KDGoF0031	17°	4,30	2,50	1,10		
KDGoF0032	17°	5,30	3,50	2,10	2,70	Ø 4,10
KDGoF0033	30°	5,70	4,50	2,10		

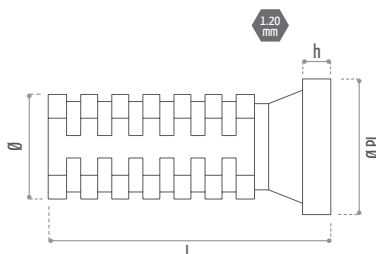

Cilindros provisionales PME - Temporary cylinder MEA (mm)				
Referencia - Reference	L	h	Ø	Ø PL
KDGoF0028	10,00	1,00	3,70	4,80
KDGoF0029	10,00	1,00	4,90	6,00

## Especificaciones técnicas - Technical specifications

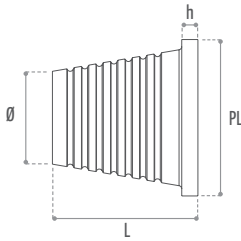

Base titanio PME - Titanium base MEA (mm)				
Referencia - Reference	L	h	Ø	Plataforma - Platform
KDGoF0035	4,50	0,50	2,85	Ø 4,80
KDGoF0036	4,50	0,50	3,95	Ø 6,00

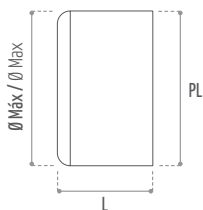

Pilares cicatrización PME - Healing abutments MEA (mm)			
Referencia - Reference	L	Ø Máx / Ø Max	Plataforma - Platform
KDPoF0035	3,80	4,80	Ø 4,80
KDPoF0037	3,80	6,00	Ø 6,00
KDPoF0036	3,80	6,00	Ø 6,00

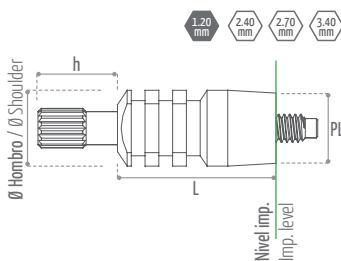

Tomas impresión cubeta abierta (CA) - Open tray (OT) impression coping (mm)						
Referencia - Reference	L	h	Ø Hombro - Ø Shoulder	Tornillo - Screw	Hex.	Plataforma - Platform
KDSoF0007	11,50	6,00	Ø 4,50	Largo - Long	2,40	Ø 3,30
KDSoF0012	11,50	---	Ø 4,50	Corto - Short		
KDSoF0002	11,50	6,00	Ø 4,50	Largo - Long	2,70	Ø 4,10
KDSoF0009	11,50	---	Ø 4,50	Corto - Short		
KDSoF0004	11,50	6,00	Ø 5,50	Largo - Long	2,70	Ø 5,10
KDSoF0010	11,50	---	Ø 5,50	Corto - Short		
KDSoF0006	11,50	6,00	Ø 5,50	Largo - Long	3,40	Ø 6,00
KDSoF0011	11,50	---	Ø 5,50	Corto - Short		
KDSoF0008	11,50	6,00	Ø 6,50	Largo - Long	3,40	Ø 6,00
KDSoF0013	11,50	---	Ø 6,50	Corto - Short		

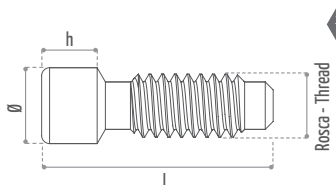

Tornillo clínica - Clinic screw (mm)				
Referencia - Reference	L	h	Ø	Rosca - Thread (mm)
KDToC0030	7,30	2,20	2,40	M2,0 x 0,40
KDToC0037	7,30	2,20	3,00	M2,5 c 0,45
KDToC0045	7,30	2,20	2,20	M1,8 x 0,35

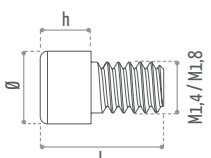

Tornillo PME - MEA screw (mm)				
Referencia - Reference	L	h	Ø	Plataforma - Platform
KDToC0056	3,40	1,40	2,00	Ø 4,80
KDToC0060	3,40	1,40	2,80	Ø 6,00





 **GMI**  
Dental implantology, S.L.  
Pol. Ind. El Segre  
C/ Enginyer Mies 705-B  
25191 Lleida (SPAIN)  
Tel. (+34) 973 184 350  
info@gmidental.com  
www.gmidental.com



Distribuido por:  
Distributed by:

