

GMI® implants system
AVANTGARD PEAK 

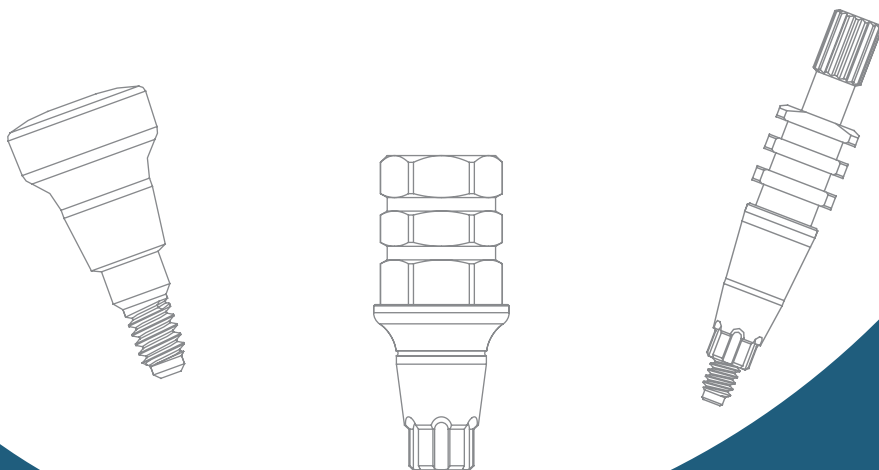

**Prosthetic
procedures
guide**

ABOUT THIS MANUAL

This prosthetic procedures guide or prosthetic manual for the **GMI® avantgard PEAK** implant system is designed solely to provide instructions for using **GMI® avantgard PEAK** products, and is not intended to describe diagnosis methods or procedures, treatment planning or the location of the implants, nor does it replace clinical training or clinical judgement about the needs of each patient. **GMI®** recommends appropriate and specific training as a prerequisite for the placement of implants and the associated treatment.

The methods illustrated and described in this manual reflect an ideal patient with the bone and soft tissue required for the placement of an implant. We do not intent to cover the wide range of adverse conditions that may negatively affect the success of the surgery or rehabilitation. **The experience and judgement of the clinician in relation to any particular case must always be above the recommendations made in this or any other GMI® manual.**

Rx only - Caution: Federal (USA) law restricts these devices to sale by, or on the order, of a dentist or physician.

TABLE OF CONTENTS



INTRODUCTION

GMI® avantgard PEAK prosthetic options	4
Abutments extraction	7

IMPRESSION COPING TECHNIQUES

Open tray impression coping direct to implant	10
Closed tray impression coping over carrier abutments	13
Open tray impression coping over multi-esthetic abutments	16
Closed tray impression coping over multi-esthetic abutments	18

TEMPORARY RESTORATIONS

Cement-retained restoration using PEEK temporary abutments	22
Screw-retained restoration using PEEK temporary abutments	25
Overdenture restoration using ME temporary cylinders	28

CEMENT-RETAINED RESTORATIONS

Cement-retained restoration over abutments	33
--	----

SCREW-RETAINED RESTORATIONS

Screw-retained restoration over multi-esthetic abutments	38
Screw-retained restoration over bioesthetic base	44

OVERDENTURE RESTORATIONS

Overdenture using Equator abutments	49
Bar overdenture over multi-esthetic abutments	52



SINGLE RESTORATION

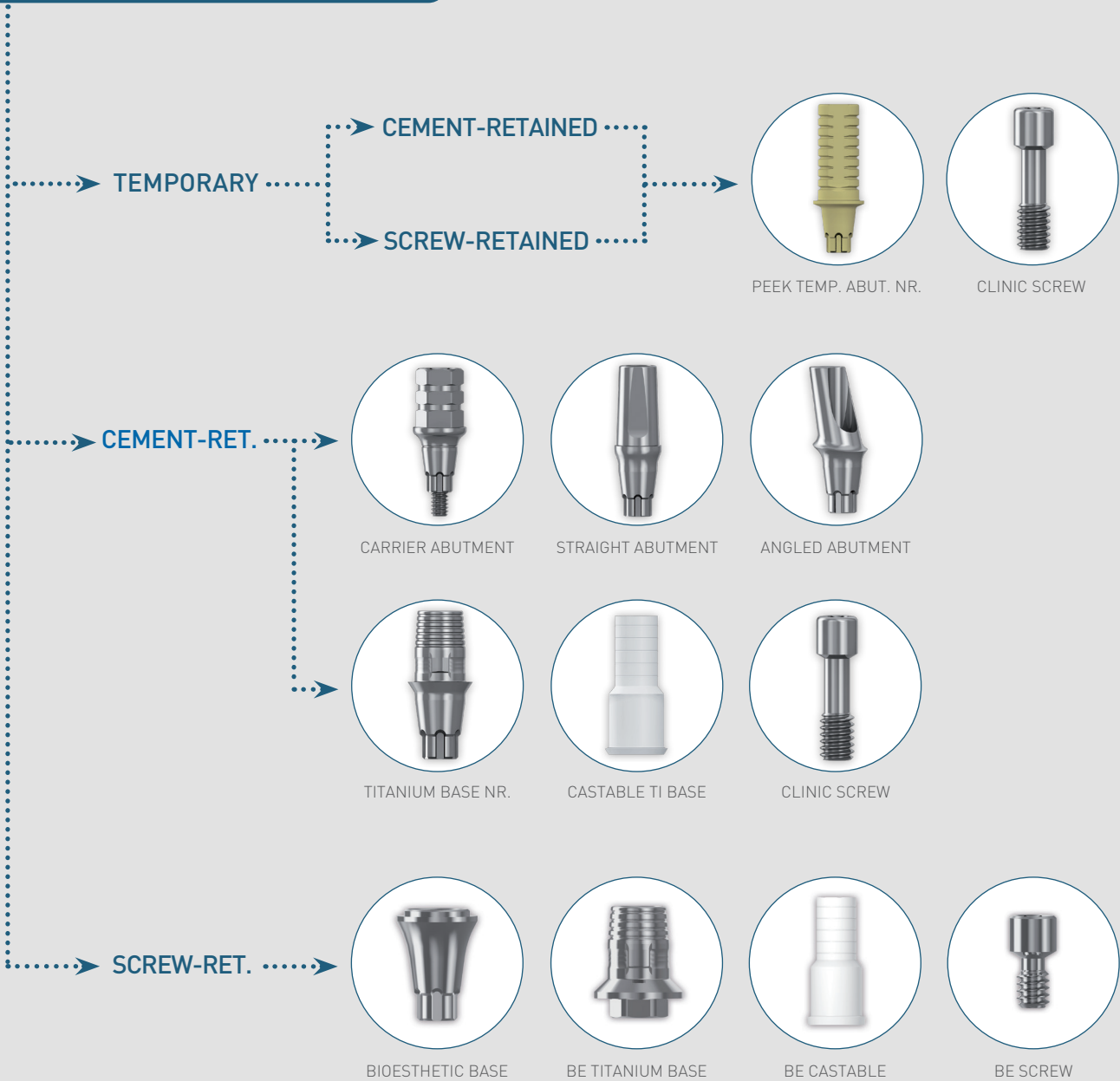

MULTIPLE RESTORATION

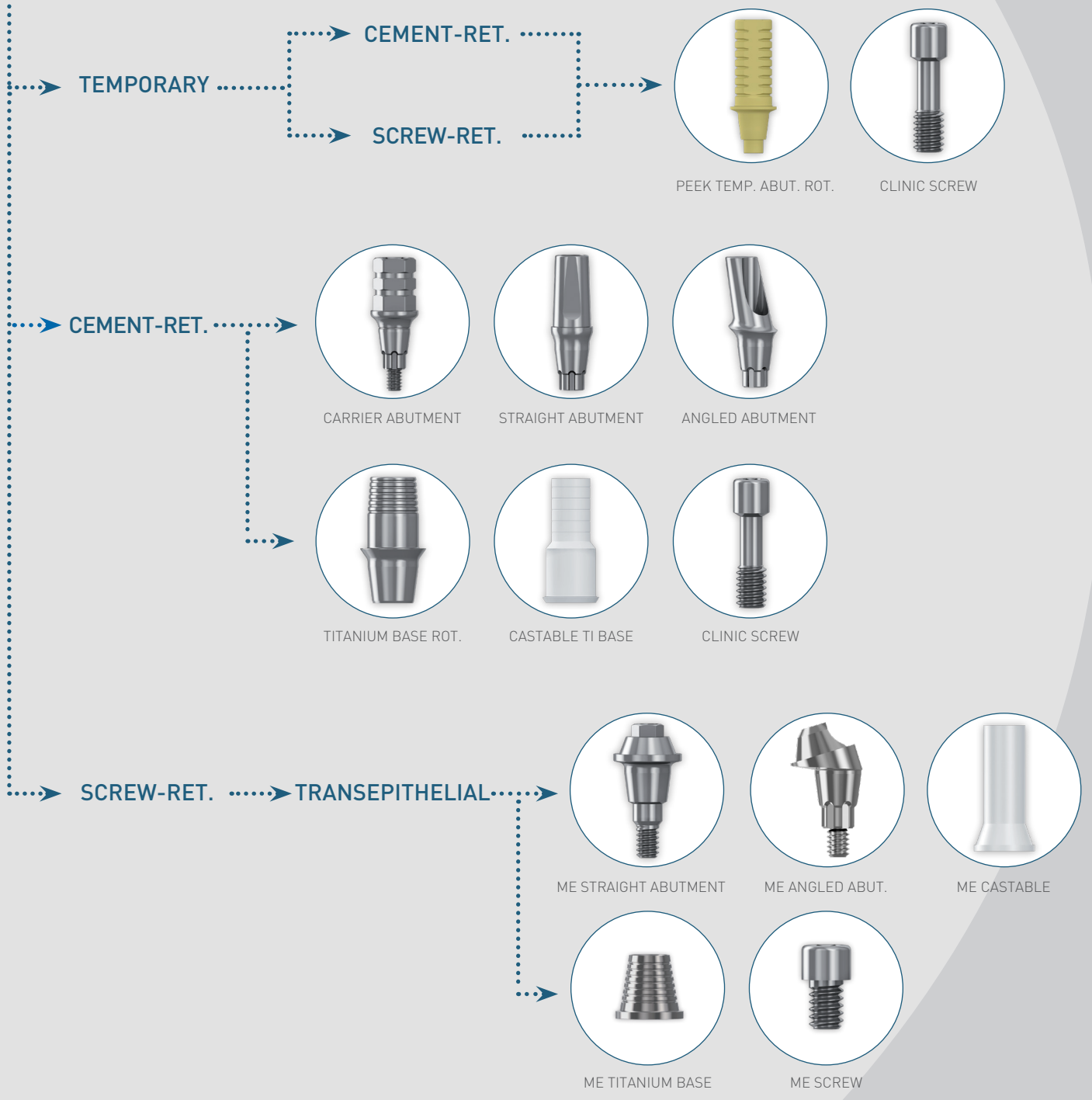

OVERDENTURE

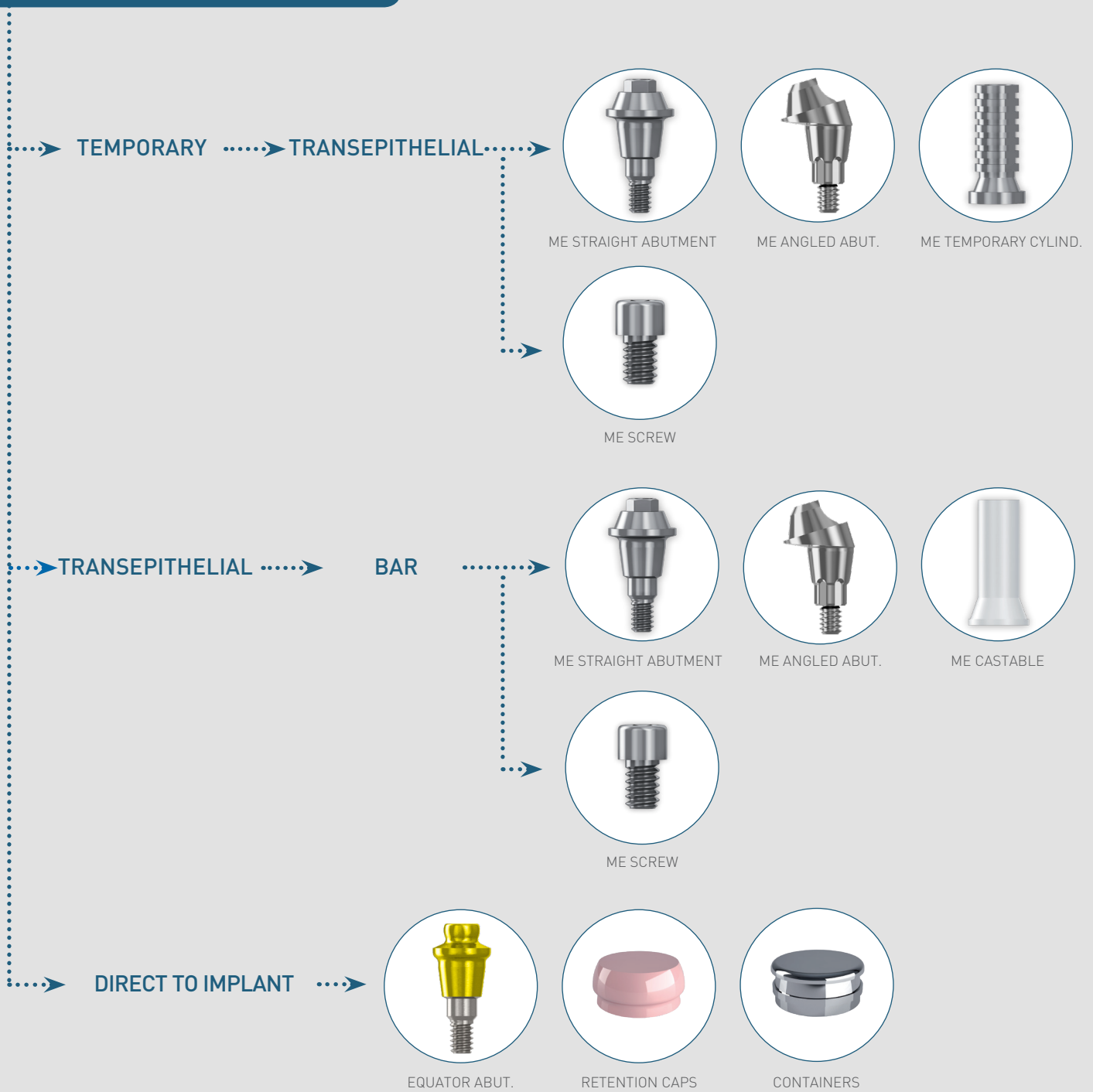

ABUTMENTS EXTRACTION



As the connection of **GMI® avantgard** implant system is a self-blocking cone, to remove the components that are fixed using the clinic screw, an extractor system must be used. There are two systems: the parts with an auto-extractor system and the parts that require the use of an extraction tool.

SELF-EXTRACTOR:

This system is only incorporated in the carrier abutments and the multi-esthetic angled abutments and do not require the use of the extractor since the extraction system is incorporated in the screw. To separate the components the following steps must be performed:

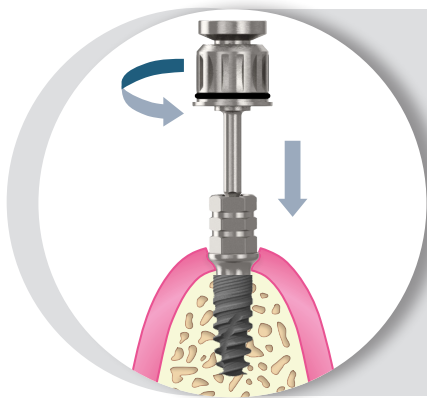

1. Loosen the screw

Loosen the screw using the HEX-1.20 mm wrench (Ref. KYLOF0128 / KYLOF0129) until the component is separated from the implant.

Note: It is normal that in the cone releasing phase a turning force greater than normal must be applied.

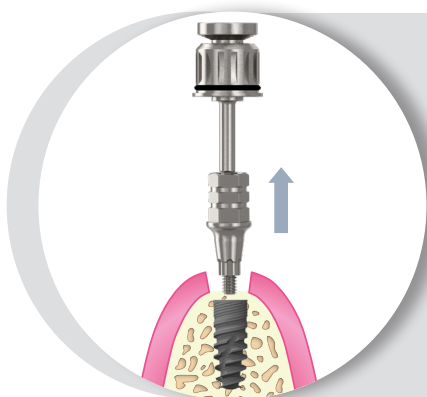

2. Remove the assembly

Remove the screw-abutment assembly from the implant.

Note: The screw can not be disassembled from the component.

AVANTGARD PEAK EXTRACTORS:

To separate the components in the rest of the abutments the **avantgard** abutments extractor wrench must be used.

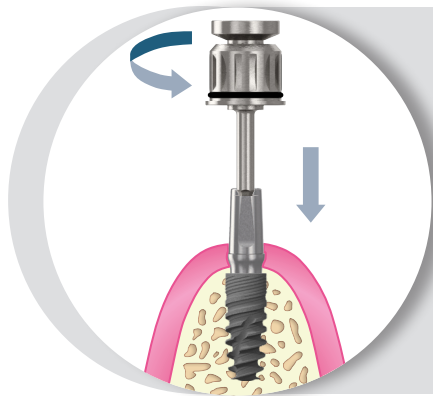

1. Loosen the screw

Loosen the abutment screw using the HEX-1.20 mm wrench (Ref. KYL0F0128 / KYL0F0129).

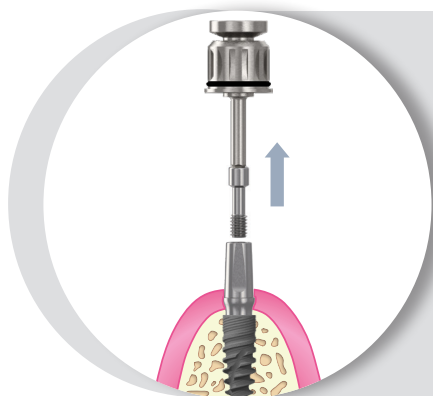

2. Remove the screw

Remove the abutment screw using a HEX-1.20 mm wrench.

Note: Take into account that the screw must be removed from the implant and the abutment.

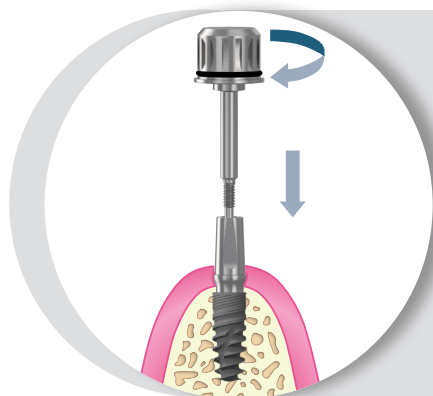

3. Extractor insertion

Insert the corresponding extractor according to implant platform (Ref. RP: KYL0F0134 and WP: KYL0F0135) and turn it clockwise until the components are separated.

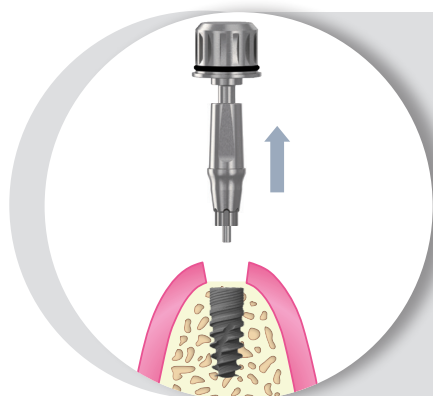

4. Remove the assembly

Remove the assembly from the implant.



IMPRESSION
COPING
TECHNIQUES

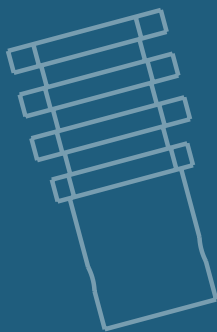
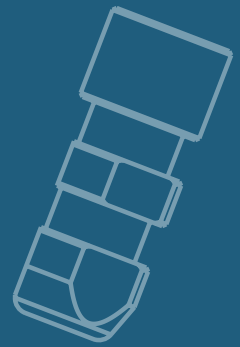

OT IMPRESSION COPING DIRECT TO IMPLANT



▶ FUNCTION

OT (Open Tray) impression coping is used to make implant-level impressions for fabrication of a working model that represents precisely the position of the implant and the soft tissue profile.

▶ REQUIRED MATERIAL



OT impression coping



Implant replica



Manual wrench
HEX-1.20

▶ PROCEDURE



Clinician



Laboratory

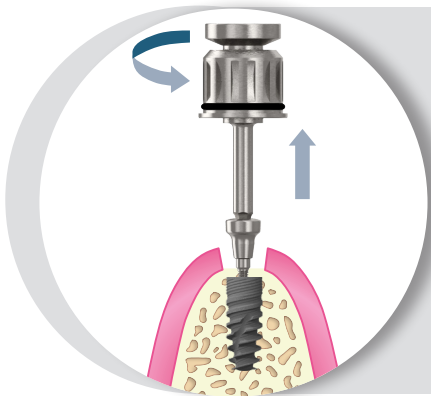

1. Remove the healing abutment



Manually remove the healing abutment from the implant using the HEX-1.20 mm wrench (Ref. KYL0F0128). Ensure that the implant connection is free of any bone debris or soft tissue.

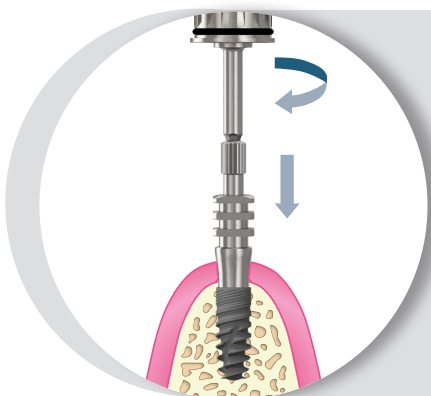

2. Place the OT impression coping



Place the impression coping on the implant body, ensuring that is correctly oriented, and retain it with the impression coping screw. Hand tighten using the knurled top or use the HEX-1.20 mm wrench (Ref. KYL0F0128) applying a maximum torque of **15 N•cm**. Take a radiograph along the long axis of the implant to ensure that the impression coping is correctly placed into the implant.

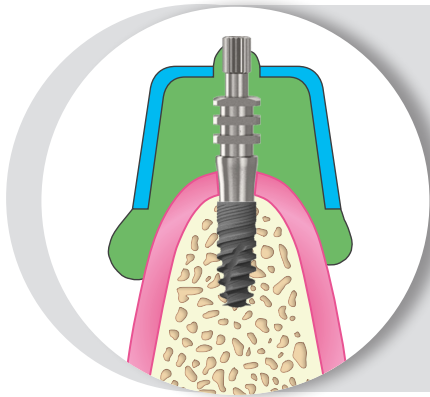

3. Impression coping

C

Use a custom tray with a hole that allows coping screw protruding through the tray without interference. Syringe a medium or heavy body elastomeric impression material around the coping body and after this load the tray. Make the impression following the manufacturer recommended procedure. Wipe the impression material from the top of the screw before the material sets.

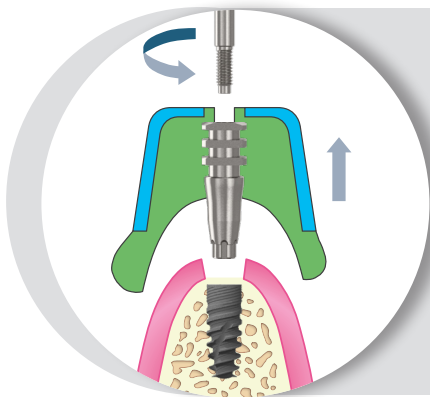

4. Remove the impression tray

C

Remove the screw by hand or using the HEX-1.20 mm wrench (Ref. KYL0F0128) and remove the tray from the mouth. Verify the impression material is completely adjusted around the coping. Replace healing abutment immediately to prevent soft tissue collapse over the implant. Send the tray and the coping screw to the lab.

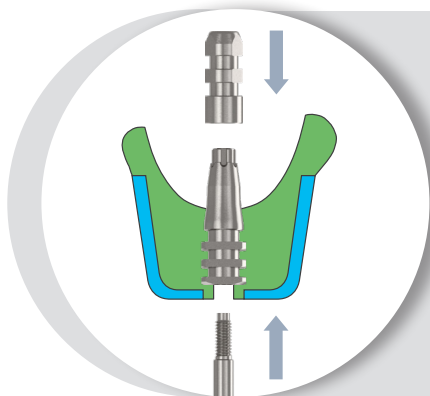

5. Assemble the replica

L

Attach the replica to the impression coping, ensuring that the hex is correctly oriented, and insert the coping screw through the access hole in the impression tray. Tighten by hand. Verify the coping and replica assembly are properly connected.

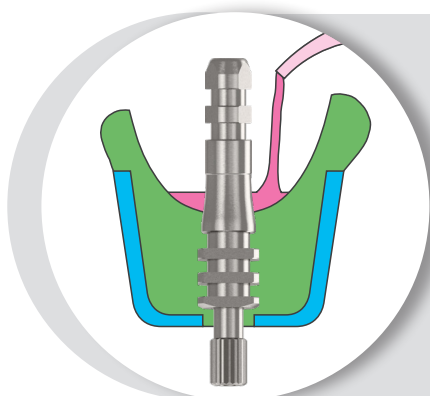

6. Make a soft tissue model

L

Syringe a soft tissue replica material around impression coping to obtain a correct simulation of soft tissue level.

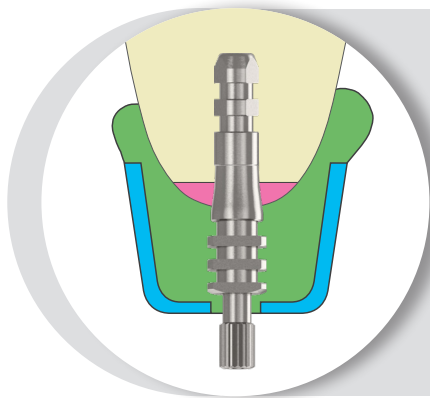

7. Fabricate the stone model



Process and pour high hardness die stone with minimal expansion into impression tray following the procedure recommended by the manufacturer.

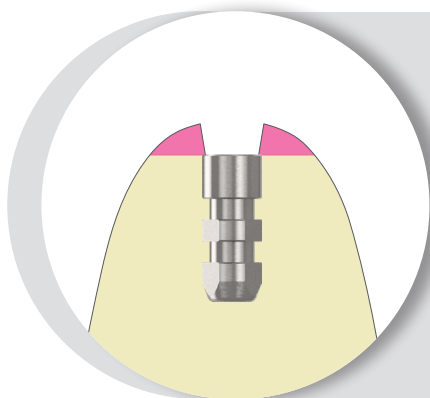

8. Finished stone model



Once the material is set, remove the impression coping screw and the tray. Make the necessary modifications to the model base and articulate according to normal laboratory procedures.

CT IMPRESSION COPING OVER CARRIER ABUTMENT



▶ FUNCTION

CT (Closed Tray) impression coping is used to make abutment-level impressions allowing to create a working model that represents precisely the position of the implant and the soft tissue profile.

▶ REQUIRED MATERIAL



Carrier abutment



CT impression coping



Implant replica



Manual wrench
HEX-1.20

▶ PROCEDURE



Clinician



Laboratory

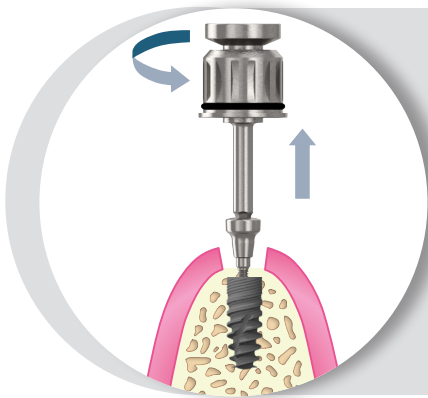

1. Remove the healing abutment



Manually remove the healing abutment from the implant using a HEX-1.20 mm wrench (Ref. KYL0F0128).

Ensure that the implant connection is free of any bone debris or soft tissue.

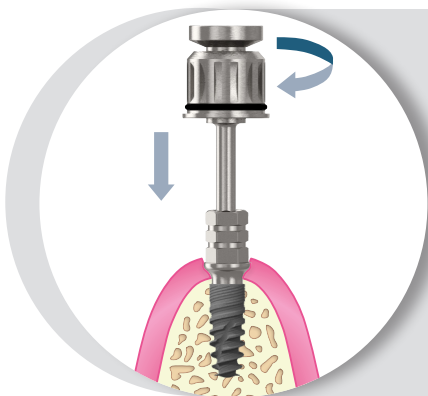

2. Place the carrier abutment



Place the millable abutment on the implant body, ensuring that it is correctly oriented, and retain it with the screw. Hand tighten or use a HEX-1.20 mm wrench (Ref. KYL0F0128) applying a maximum torque of **15 N-cm**. Take a radiograph along the long axis of the implant to ensure that the millable abutment is correctly placed into the implant.

Note: The carrier screw is not removable as it works as an extractor.

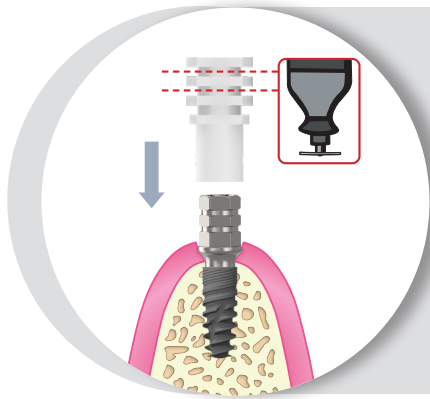

3. Place the CT impression coping

C

Place the plastic CT impression coping on the carrier abutment body, ensuring that the hex is correctly oriented, until it has been perfectly placed. Check assembly height and cut if necessary, leaving at least two retentions.

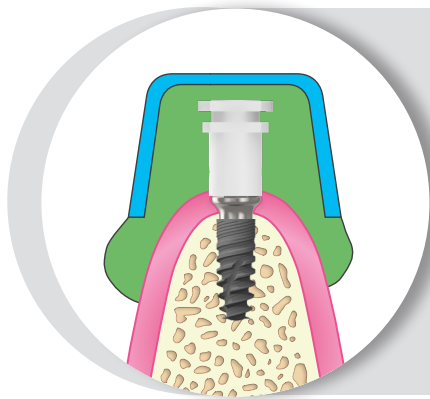

4. Impression coping

C

Use a custom or standard tray. Syringe a medium or heavy body elastomeric impression material around the coping body and after this load the tray. Make the impression following the impression material manufacturer recommended procedure.

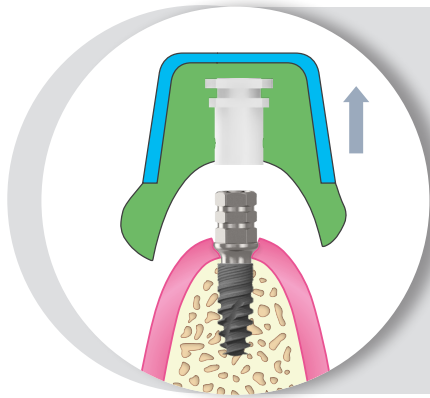

5. Remove the impression tray

C

Remove the tray from the mouth with the impression coping embedded. Verify the impression material is completely adjusted around the coping. Loosen the screw and remove the abutment from implant body. Replace healing abutment immediately to prevent soft tissue collapse over the implant. Send the tray and the millable abutment to the lab.

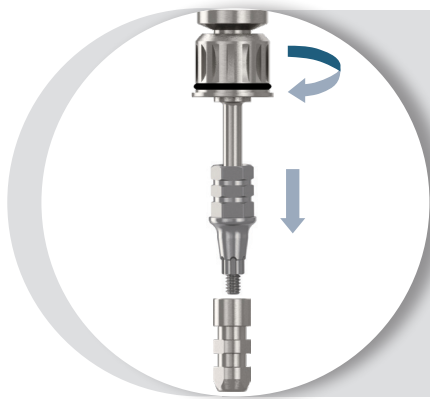

6. Assemble the replica

L

Attach the replica to the millable abutment, ensuring that is correctly oriented, and tighten the assembly with the screw by hand with the HEX-1.20 mm wrench. Verify that the abutment and replica assembly are properly connected.

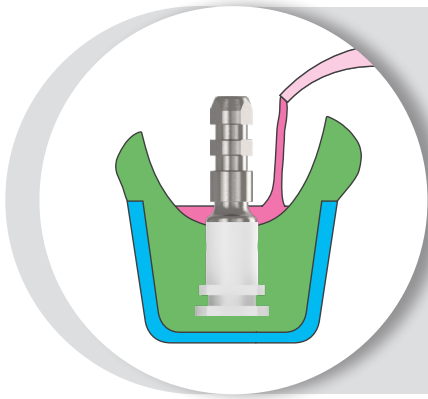

7. Make a soft tissue model



Insert replica-abutment assembly on CT plastic impression coping, ensuring that the hex is correctly oriented. Syringe a soft tissue replica material around the impression coping to obtain a correct simulation of the soft tissue level.

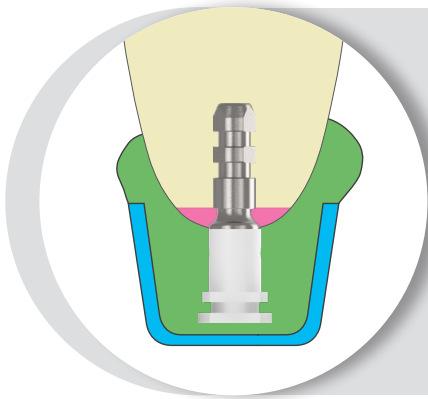

8. Fabricate the stone model



Process and pour high hardness die stone with minimal expansion into impression tray following the procedure recommended by the manufacturer.

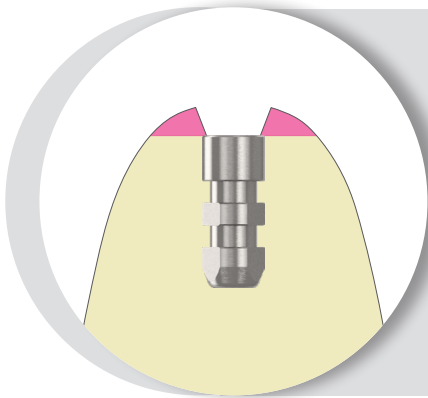

9. Finished stone model



Once the material is set, remove the impression coping screw and the tray. Make the necessary modifications to the model base and articulate according to normal laboratory procedures.

OT IMPRESSION COPING OVER ME ABUTMENTS



▶ FUNCTION

OT (Open Tray) impression coping is used to make implant-level impressions allowing to create a working model that represents precisely the position of the implant and the soft tissue profile.

▶ REQUIRED MATERIAL



OT impression coping MEA



MEA replica



Manual wrench
HEX-1.20

▶ PROCEDURE



Clinician



Laboratory

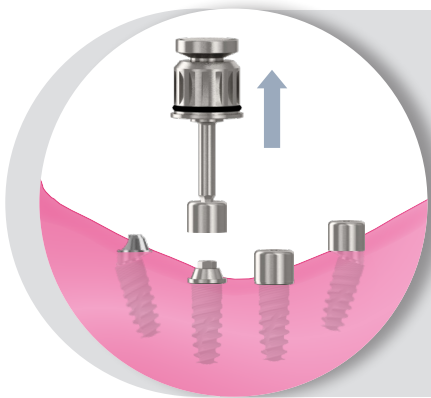

1. Remove the healing abutments



Manually remove the ME healing abutments from the multi-esthetic abutments using a HEX-1.20 mm wrench (Ref. KYL0F0128). Ensure that the ME abutment connections are free of any bone debris or soft tissue.

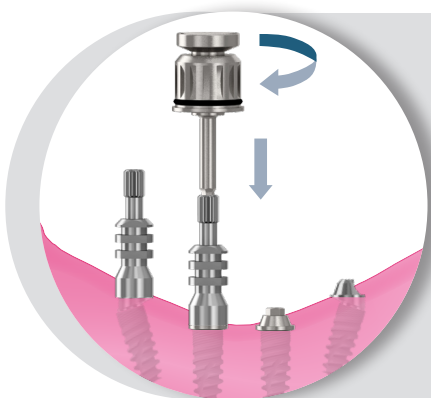

2. Place the OT impression coping



Place the ME impression coping on the ME abutments, ensuring that the impression coping base is correctly placed over the ME abutments, and retain it with an impression coping screw. Hand tighten using the knurled top or use a HEX-1.20 mm wrench (Ref. KYL0F0128) applying a maximum torque of **15 N•cm**.

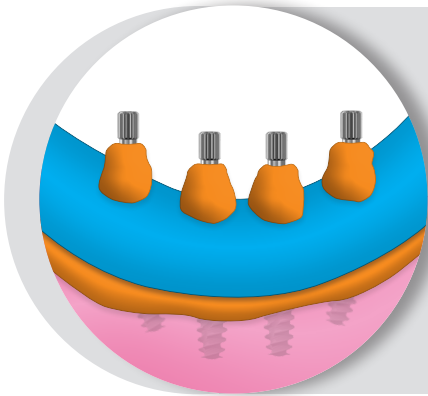

3. Impression coping

C

Use a custom tray with holes that allows the coping screws to protrude through the tray without interference. Syringe a medium or heavy body elastomeric impression material around the coping body and after this load the tray. Make the impression following the impression material manufacturer recommended procedure. Wipe the impression material from the top of the screws before the material sets.

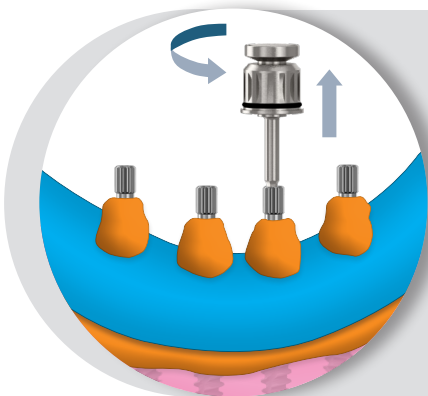

4. Remove the impression tray

C

Remove the screws by hand or using the HEX-1.20 mm wrench (Ref. KYL0F0128) and remove the tray from the mouth. Verify that the impression material is completely adapted around the copings. Replace healing abutments. Send the tray and the coping screws to the lab.

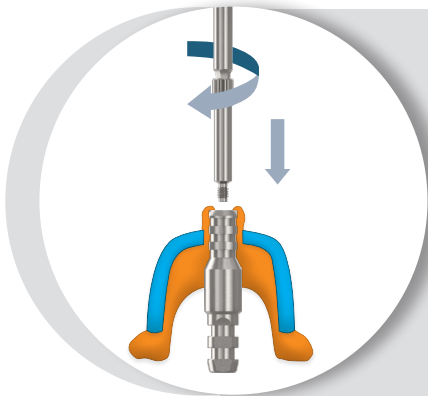

5. Assemble the replicas

L

Attach the ME replicas to the impression copings and insert the coping screws through the access holes in the impression tray. Tighten by hand using the HEX-1.20 mm wrench (Ref. KYL0F0128). Verify that the coping and replica assemblies are properly connected.

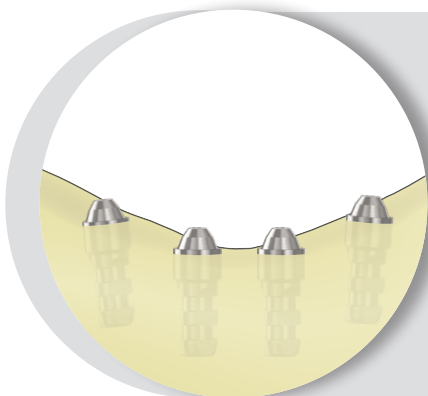

6. Fabricate the stone model

L

Process and pour high hardness die stone with minimal expansion into impression tray following the procedure recommended by the manufacturer. Once the material is set, remove the impression coping screws and the tray. Make the necessary modifications to the model base and articulate according to normal laboratory procedures.

CT IMPRESSION COPING OVER ME ABUTMENTS



▶ FUNCTION

CT (Close Tray) impression coping is used to make abutment-level impressions allowing to create a working model that represents precisely the position of the implant and the soft tissue profile.

▶ REQUIRED MATERIAL



CT impression coping MEA



MEA replica



Manual wrench
HEX-1.20

▶ PROCEDURE



Clinician



Laboratory

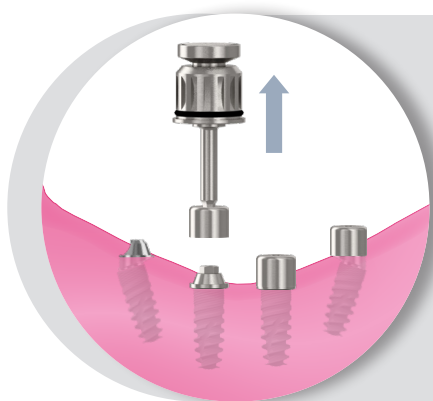

1. Remove the healing abutments



Manually remove the ME healing abutments from the multi-esthetic abutments using a HEX-1.20 mm wrench (Ref. KYL0F0128). Ensure that the ME abutment connections are free of any bone debris or soft tissue.

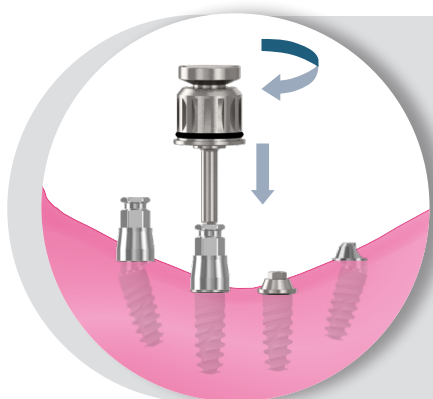

2. Place the metallic part of the CT impression coping



Place the metallic part of the CT impression coping on the ME abutments, ensuring that the impression coping base is correctly placed over the ME abutments, and retain it with an impression coping screw. Hand tighten using the knurled top or use a HEX-1.20 mm wrench (Ref. KYL0F0128) applying a maximum torque of **15 N•cm**.

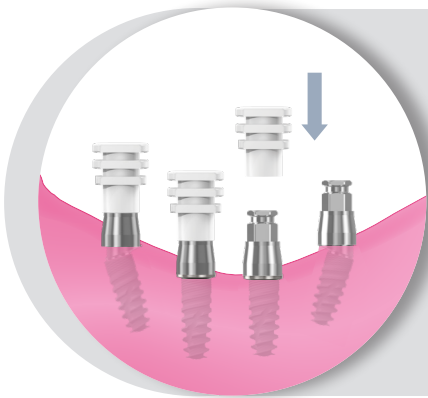

3. Place the plastic sleeves of the CT impression copings



Insert under pressure the plastic sleeves of the CT impression copings over the metallic part ensuring that the hex is correctly oriented. Check that they seat correctly in the metallic piece.

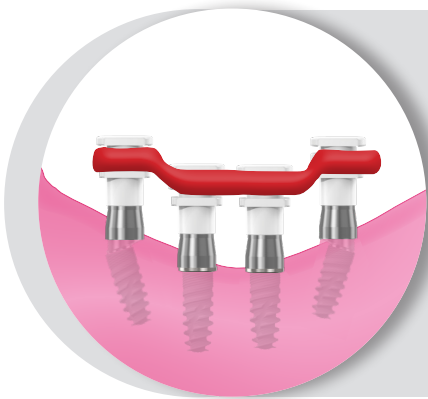

4. Splint the impression copings



Use dental floss or orthodontic wire to connect all the impressions. Apply resin or curable material with light on the wire or floss to splint together all the impression copings. Retouch and soften the acrylic as necessary.

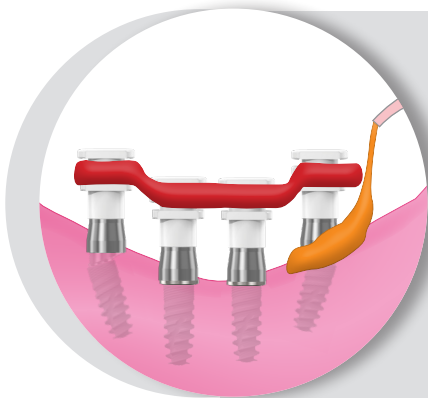

5. Syringe a impression material



Syringe a medium or heavy body elastomeric impression material around the impression copings.

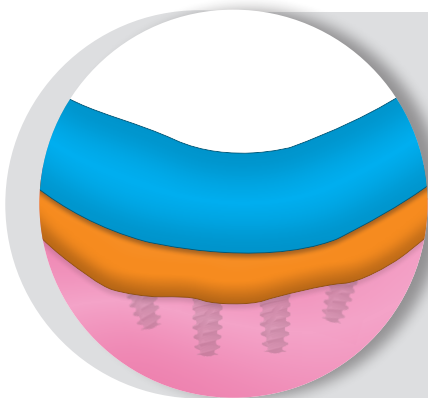

6. Impression coping



Use a custom or standard tray. Make the impression following the impression material manufacturer recommended procedure.

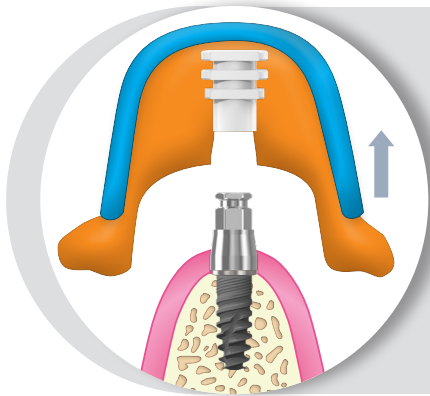

7. Remove the impression tray

C

Remove the tray from the mouth with the plastic sleeve embedded. Verify the impression material is completely adjusted around the coping. Loosen the screw and remove the metallic piece from implant body. Replace healing abutment immediately to prevent soft tissue collapse over the implant. Send the tray and the impression coping to the lab.

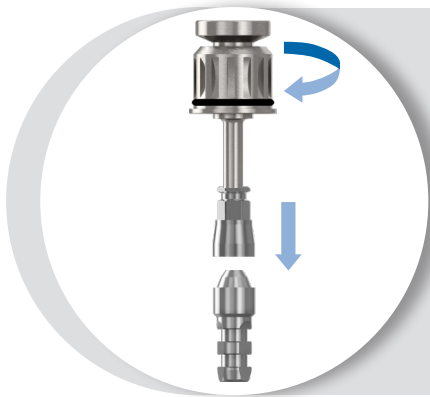

8. Assemble the replicas

L

Attach the metallic piece of the impression copings to the replica and tighten with the screw by hand with the HEX-1.20 mm wrench (Ref. KYL0F0128).

Verify that the assembly is properly connected.

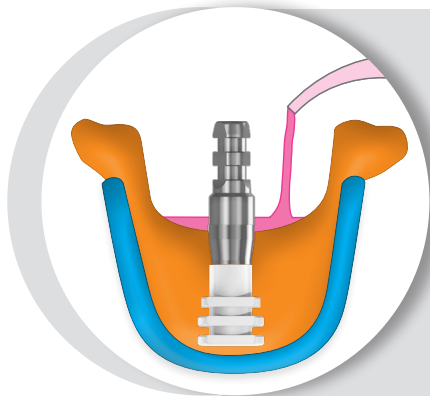

9. Make a soft tissue model

L

Insert replica-metallic piece assembly on the plastic sleeve. Syringe a soft tissue replica material around the impression coping to obtain a correct simulation of the soft tissue level.

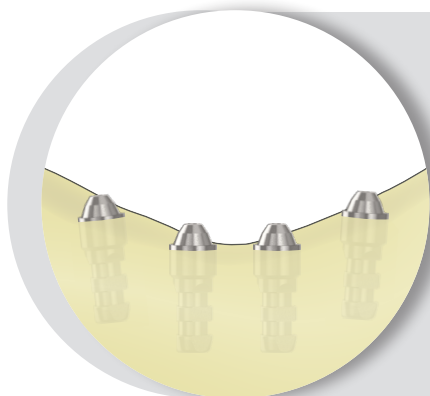

10. Fabricate the stone model

L

Process and pour high hardness die stone with minimal expansion into impression tray following the procedure recommended by the manufacturer. Once the material is set, remove the tray. Make the necessary modifications to the model base and articulate according to normal laboratory procedures.

TEMPORARY RESTORATIONS

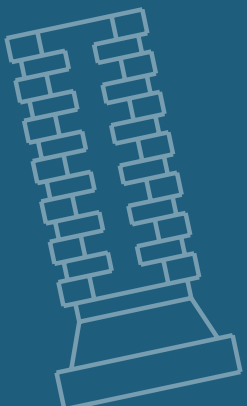
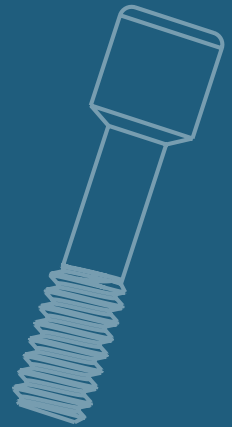

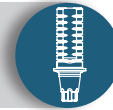

▶ FUNCTION

PEEK temporary abutments are used for the fabrication of short-term (less than 30 days) temporary multiple or single restorations, allowing model soft tissue and obtaining esthetic results while the final prosthesis is being manufactured.

▶ REQUIRED MATERIAL



PEEK temp. abut. NR



PEEK temp. abut. R



Clinic screw



Manual wrench
HEX-1.20

▶ PROCEDURE

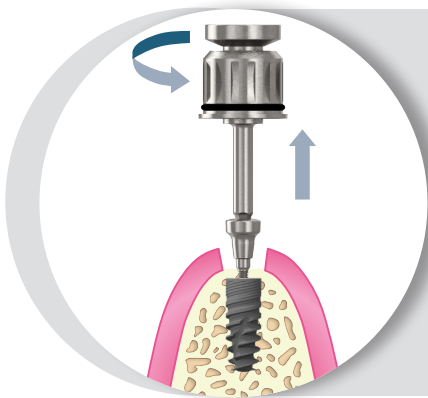

1. Remove the healing abutment

Manually remove the healing abutment from the implant using a HEX-1.20 mm wrench (Ref. KYLOF0128). Ensure that the implant connection is free of any bone debris or soft tissue.

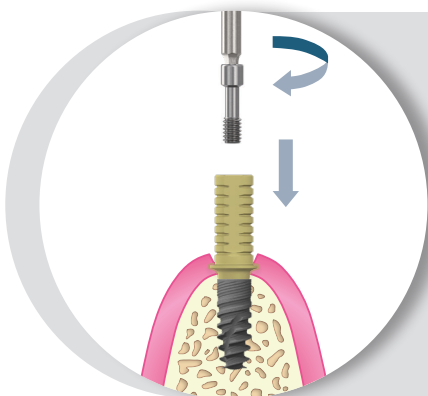

2. Place the PEEK abutment

Place the PEEK abutment on the implant body, ensuring that it is correctly oriented, and retain it with a clinic screw. Hand tighten using a HEX-1.20 mm wrench (Ref. KYLOF0128) applying a maximum torque of **15 N•cm**. Mark the abutment for the required vertical reduction and gingival contour.

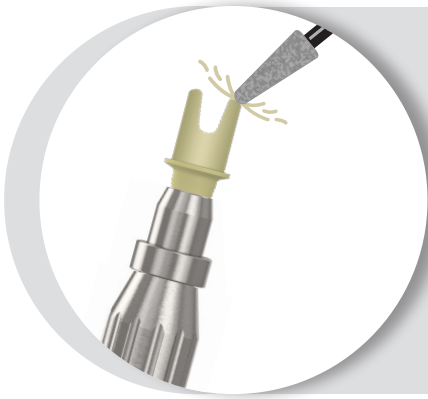

3. Modify the abutment

Remove abutment from the implant and replace the healing abutment immediately to prevent soft tissue collapse over the implant. Insert **avant-gard** tip (Ref. KYLOC0137) for the corresponding platform (RP/WP) on the universal handle (Ref. KYLOF0076). Engage both pieces and tighten the screw by hand using a HEX-1.20 mm wrench (Ref. KYLOF0128). Modify the abutment following the marks of the previous step.

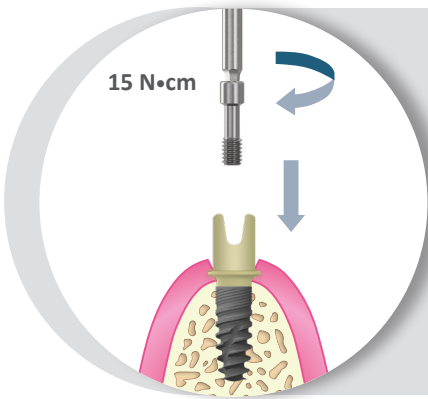

4. Place the modified PEEK abutment

Place the modified PEEK abutment on the implant, ensuring that is correctly oriented, and retain it with a clinic screw. Hand tighten using a HEX-1.20 mm wrench (Ref. KYLOF0128) applying a maximum torque of **15 N•cm**.

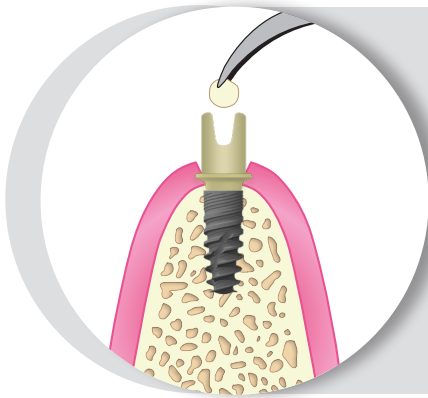

5. Block the screw access hole

Place a resilient material of choice (gutta-percha, silicone or temporary filling material) into the screw access hole and fill the remaining channel with composite or another material of choice. This allows for easy access to the abutment screw in the future.

Apply a separating solution onto the PEEK abutment for fabricating the temporary crown.

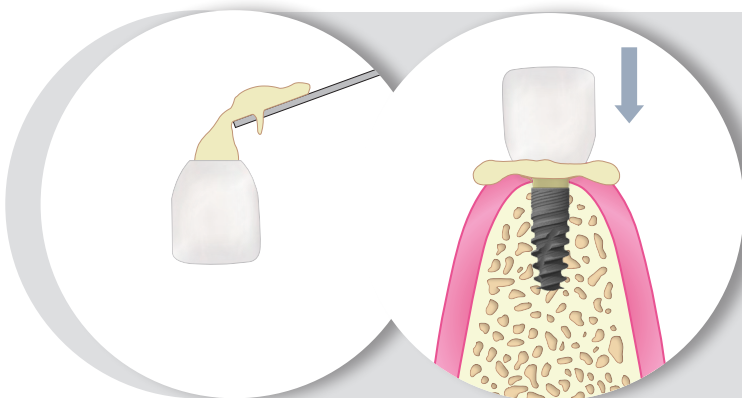

6. Select and fill the shell crown

Select the appropriate poly-carbonate shell crown and modify as needed following conventional procedures. Mix acrylic or another material of choice, fill the crown and place the crown over modified temporary abutment.

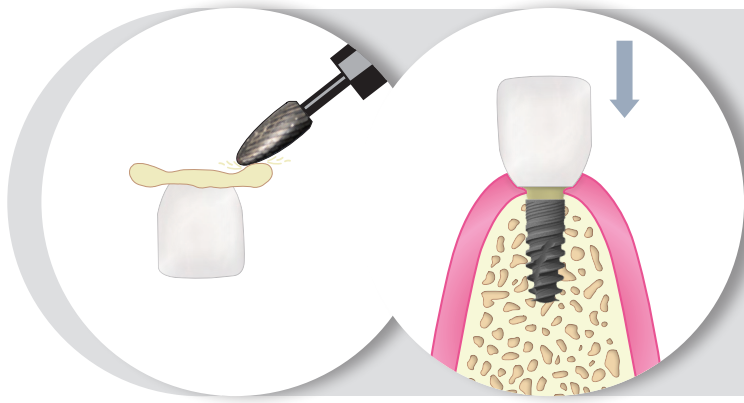

7. Remove acrylic excess, adjust and cement

Remove the excess crown acrylic and polish. Test in the crown and check the occlusion, fit and contour. Modify as necessary and polish after making adjustments. Clean the separation solution from the prepared plastic and cement the crown following the manufacturer recommended procedure.

SCREW-RETAINED RESTORATION USING PEEK TEMP. ABUT.

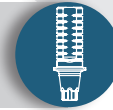

► FUNCTION

PEEK temporary abutments are used for the fabrication of short-term (less than 30 days) temporary multiple or single restorations, allowing model soft tissue and obtaining esthetic results while the final prosthesis is being manufactured.

► REQUIRED MATERIAL



PEEK temp. abut. NR



PEEK temp. abut. R



Clinic screw



Imp. long screw



Manual wrench
HEX-1.20

► PROCEDURE

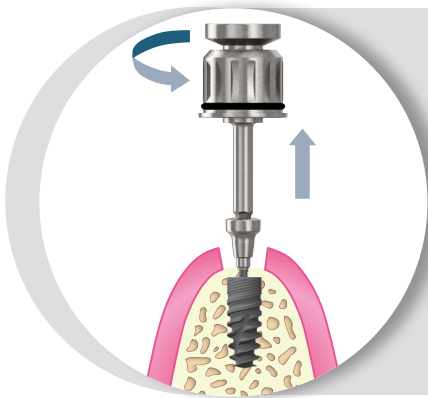

1. Remove the healing abutment

Manually remove the healing abutment from the implant using a HEX-1.20 mm wrench (Ref. KYL0F0128). Ensure that the implant connection is free of any bone debris or soft tissue.

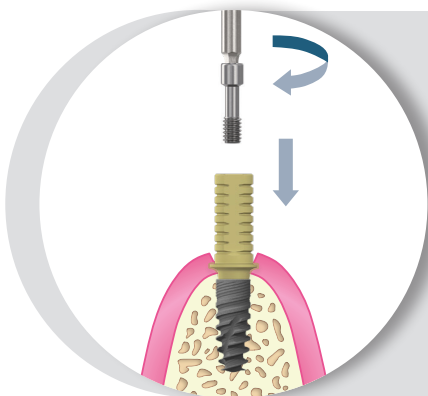

2. Place the PEEK abutment

Place the PEEK abutment on the implant body, ensuring that it is correctly oriented, and retain it with a clinic screw. Hand tighten using a HEX-1.20 mm wrench (Ref. KYL0F0128) applying a maximum torque of **15 N•cm**. Mark the abutment for the required vertical reduction and gingival contour.

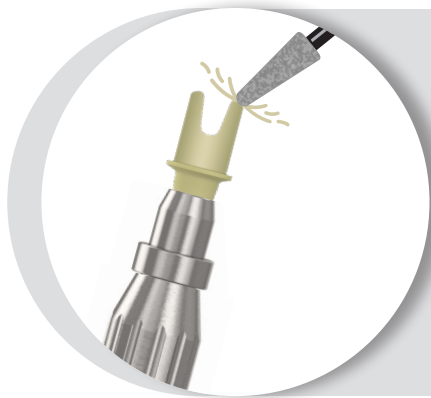

3. Modify the abutment

Remove the abutment from the implant and replace the healing abutment immediately to prevent soft tissue collapse over the implant. Insert **avantgard** tip (Ref. KYL0C0137) for the corresponding platform (RP/WP) on the universal handle (Ref. KYL0F0076). Engage the tip and abutment and tighten the screw by hand using a HEX-1.20 mm wrench (Ref. KYL0F0128). Modify the abutment following the marks of the previous step.

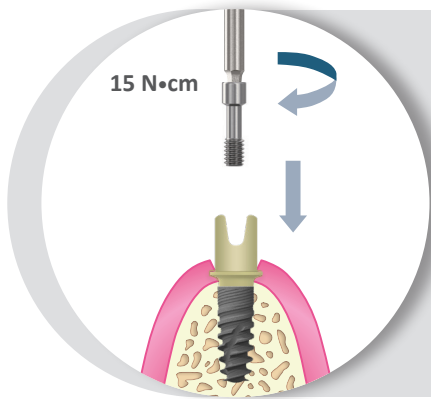

4. Place the modified PEEK abutment

Place the modified PEEK abutment on the implant, ensuring that is correctly oriented, and retain it with a clinic screw. Hand tighten using a HEX-1.20 mm wrench (Ref. KYL0F0128) applying a maximum torque of **15 N•cm**.

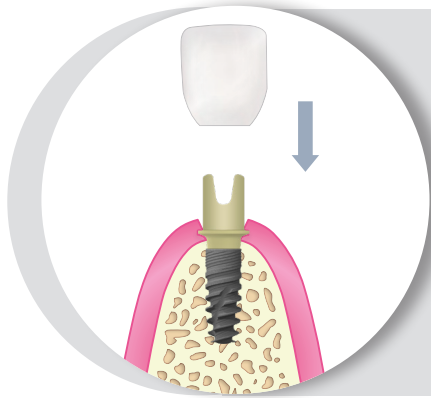

5. Select and adjust the shell crown

Select the appropriate poly-carbonate shell crown and modify as needed following conventional procedures.

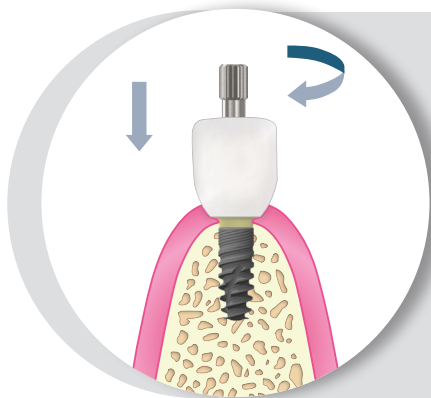

6. Insert impression coping screw and create access hole

Remove the clinic screw and replace it with a long impression coping screw. Tighten by hand using knurled top or a HEX-1.20 mm wrench (Ref. KYL0F0128). Select and create an access hole through the shell crown allowing the long impression coping screw to come through.

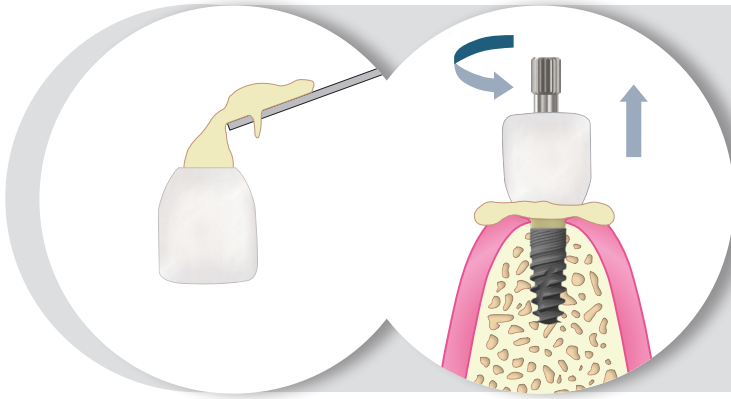

7. Select and fill the shell crown

Mix acrylic or another material of choice, fill the crown and place the crown over modified temporary abutment. We recommend block-outing undercuts on adjacent teeth to avoid acrylic adhesion. When the acrylic is set remove the coping screw and the shell crown.

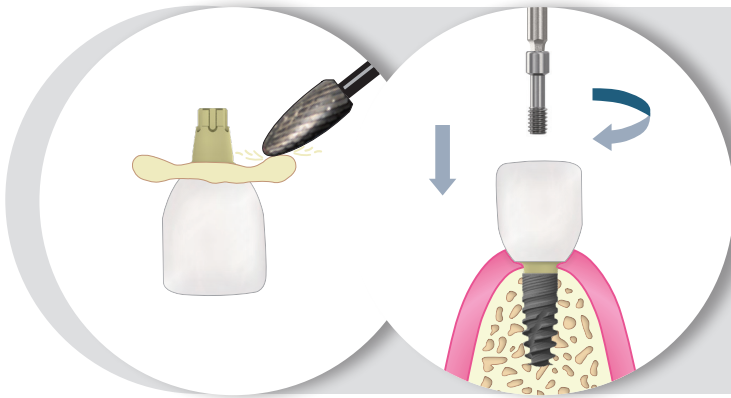

8. Remove acrylic excess, adjust and cement

Remove the excess crown acrylic and polish. Test in the crown, tighten clinic screw and check the occlusion, fit and contour. Modify as necessary and polish after making adjustments.

OVERDENTURE REST. USING ME TEMP. CYLINDERS



► FUNCTION

Titanium ME temporary cylinders are used to make temporary screw-retained full-arch restorations with an existing or new acrylic overdenture, while the final prostheses is being manufactured.

► REQUIRED MATERIAL



ME straight abut.



ME angled abut.



ME temporary cylinder



MEA screw



Manual wrench
HEX-1.20



MEA wrench
HEX-2.00



Angled MEA
wrench



TI ratchet wrench

► PROCEDURE

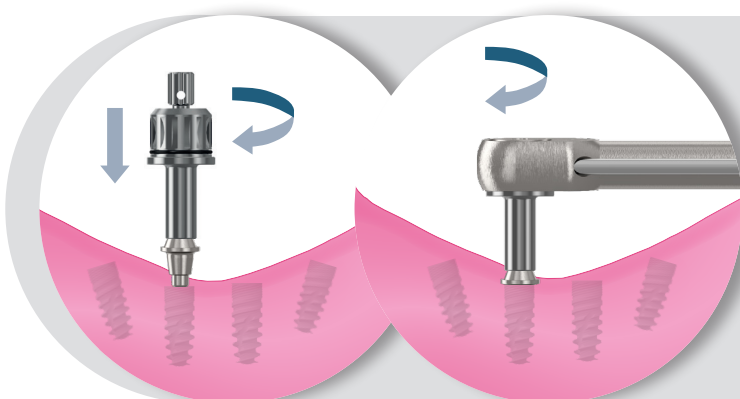

1. Select and place ME straight abutments

Select straight ME abutment diameter and gingival height according to implant platform and soft tissue depth. Place the selected abutment on the implant body and hand tighten using the corresponding ME abutment wrench (Ref. KYLOF0180). Tighten the abutments to **30 N•cm** using TI ratchet wrench.

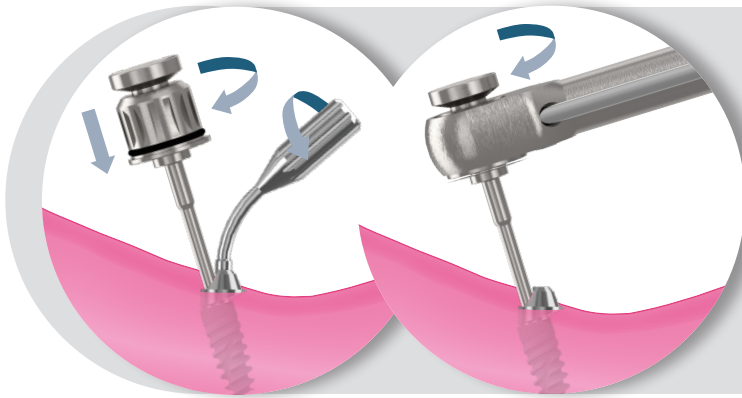

2. Select and thread the ME angled abutments

Select the height and angle of the ME abutments depending on the angle and soft tissue thickness. Position the abutment and screw the angled ME abut. to the implant manually with the wrench (Ref. KYLOF0130). Unscrew the abutment guide and finish the tightening with the wrench attached to the TI torque wrench using a torque of **20 N•cm**.

Note: The ME angled abutment screw is not removable as it works as an extractor.

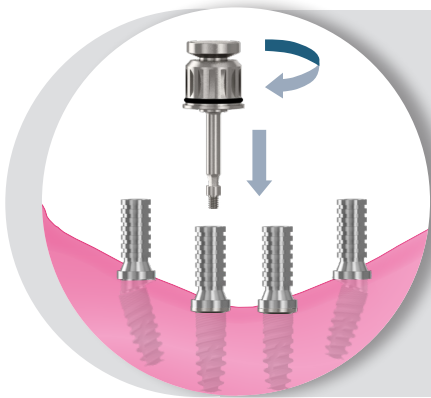

3. Place ME temporary cylinders

Place the temporary cylinders on the ME abutments and hand tighten using ME clinic screws with a HEX-1.20 mm wrench (Ref. KYLOF0128).

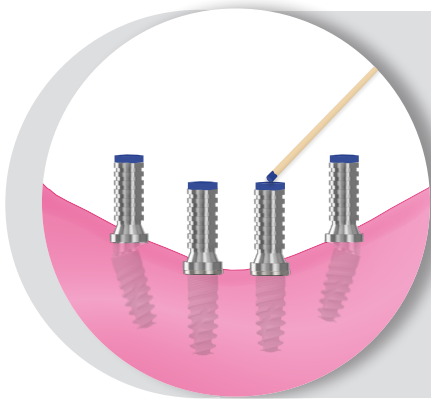

4. Mark temporary cylinders

Mark the top surface of the temporary cylinders using a suitable marker.

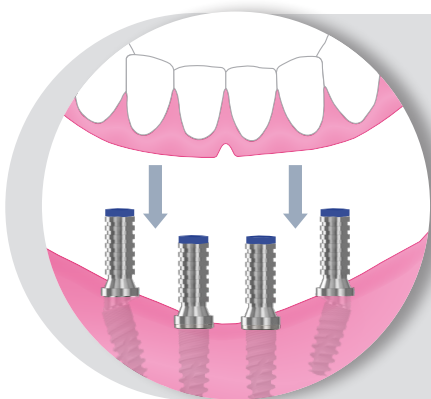

5. Transfer temporary cylinders position to denture

Place patient's provisional denture in the mouth and press it onto the temporary cylinders to transfer colored ink to the denture. The provisional denture may be the patient's existing denture or a newly made immediate denture ready for insertion into the mouth. Remove denture from the mouth and check visibility of the marks.



6. Drill holes for temporary cylinders

Use an acrylic bur or laboratory bur to relieve the denture base in the marked areas. Continue to remove acrylic until holes are made completely through the denture.

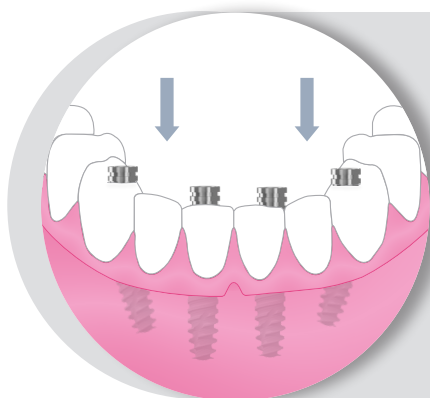

7. Test in modified denture

Reseat the denture into the mouth to confirm that there is relief around the temporary cylinders and that the rest of the denture base is in contact with the soft tissue. Make the necessary modifications to achieve a proper adjustment and occlusion.

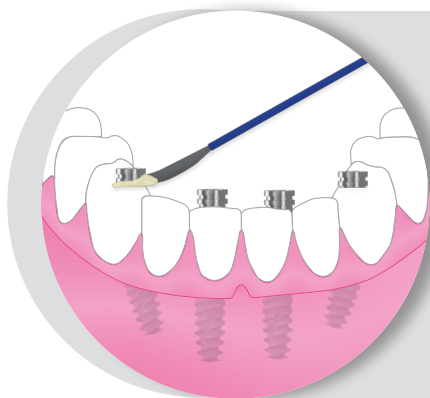

8. Attach temporary cylinders to denture

Block out screw access holes with cotton pellet or material of choice to prevent acrylic from getting into the holes. Use fluid composite or acrylic auto-cure resin to attach temporary cylinders to the denture following the manufacturer recommended procedure and wait for the resin to be completely set.

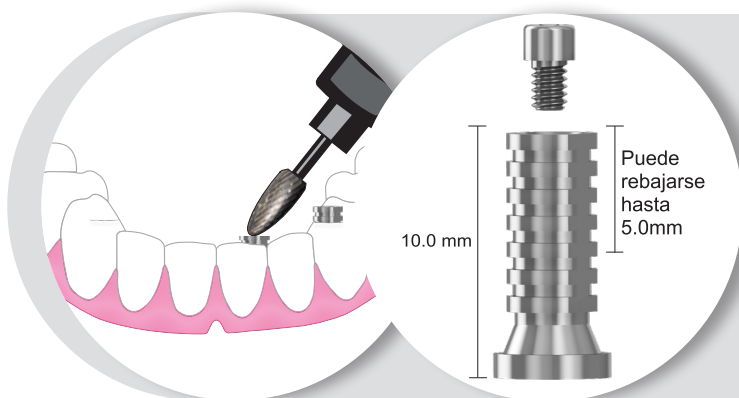

9. Remove and adjust denture

Remove ME clinic screws using a HEX-1.20 mm wrench (Ref. KYLOF0128) and remove denture from the patient's mouth. Ensure that the temporary cylinders are properly attached to the denture, adjust the denture flange, and remove any excess resin and/or fill in any voids with additional denture repair resin. Shorten temporary cylinders with a bur avoiding denture overheating. Make the final adjustments and polish the entire prosthesis.

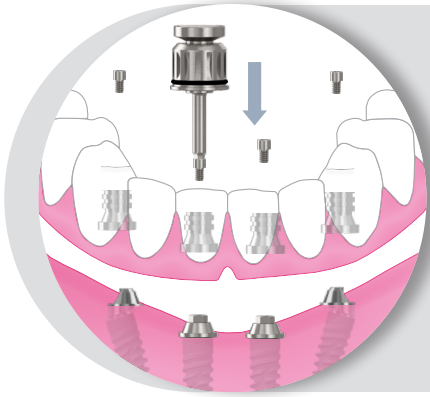

10. Reseat denture into the mouth

Reseat denture into the patient's mouth and confirm that it is completely placed on the multi-esthetic abutments. Place the ME clinic screws through the temporary cylinders and hand tighten using a HEX-1.20 mm wrench (Ref. KYLOF0128).

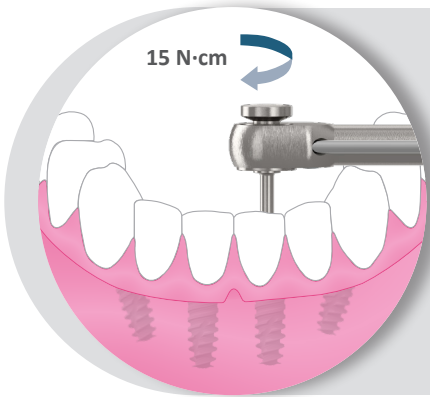

11. Temporary denture final tightening

Tighten ME clinic screws to **15 N·cm** using TI ratchet wrench.

Important note: To prevent screw damage do not apply more than **15 N·cm**.

CEMENT-RETAINED RESTORATIONS

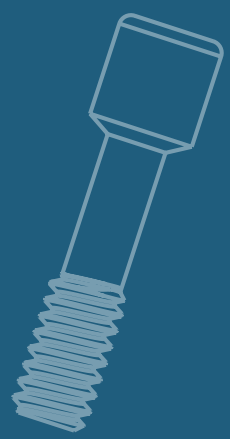

CEMENT-RETAINED RESTORATION OVER ABUTMENTS



► FUNCTION

Cementable abutments are used to perform single and multiple cement-retained restorations. Once the abutments have been modified and the crown or bridge has been fabricated in the laboratory, the abutments are attached to the implant using the clinic screw and the crown/s are cemented directly over the abutments.

► REQUIRED MATERIAL



Carrier abutment



Straight abutment



Angled abutment



Clinic screw



Laboratory screw



Manual wrench
HEX-1.20



Laboratory wrench HEX-1.20



TI ratchet wrench

► PROCEDURE



Clinician



Laboratory

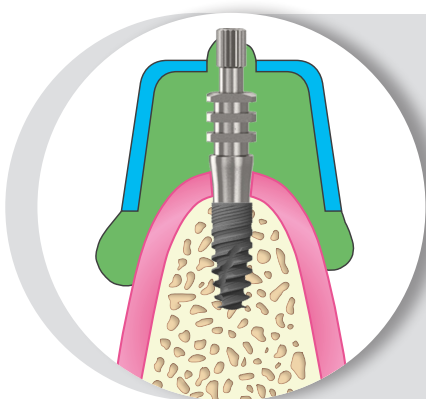

1. Impression coping



Make an implant-level impression using open tray (OT) or closed tray (CT) technique following the procedures explained in the corresponding section.

Send the components to the lab.

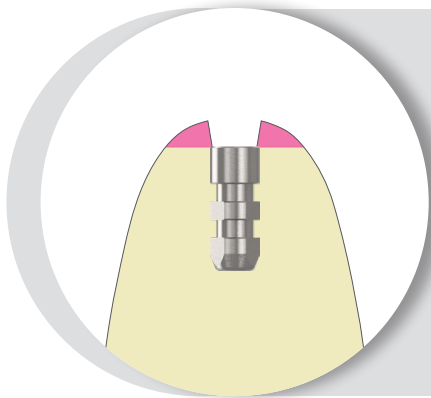

2. Fabricate the working model



Fabricate stone working model, model soft tissue and articulate the following conventional laboratory procedures.

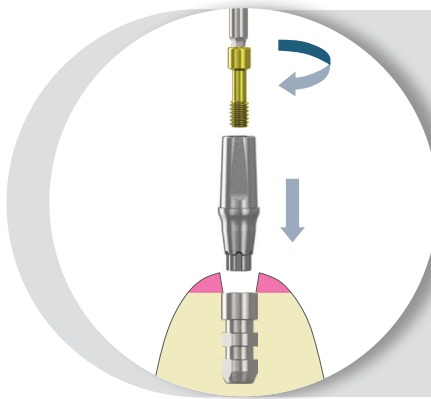

3. Select and place the abutment



Select the abutment according to implant platform, gingival height and implant divergence. Place the abutment on the replica ensuring that is correctly oriented, and hand tighten the lab screw using a lab HEX-1.20 mm wrench (Ref. KYLOF0006). Evaluate inter-occlusal dimensions, angulations and soft tissue contour. Mark the abutment for the required modifications allowing a minimum of 1.5-2.0 mm of occlusal clearance for metal and porcelain.

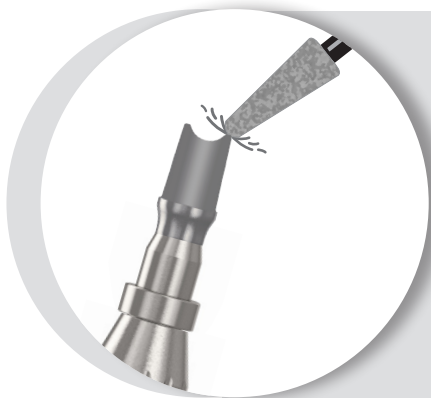

4. Modify the abutment



Remove the marked abutment from the replica and place it onto the universal handle with the proper tip. Modify the abutment following the marks of the previous step using carbide burs, cut-off disks or heatless stone wheels. A diamond bur may be used to define the margins. Create a mark on the buccal surface to make re-indexing the abutment in the mouth easier. If the flat of the abutment is removed during preparation, a new anti-rotational feature must be established on the abutment for single restorations.

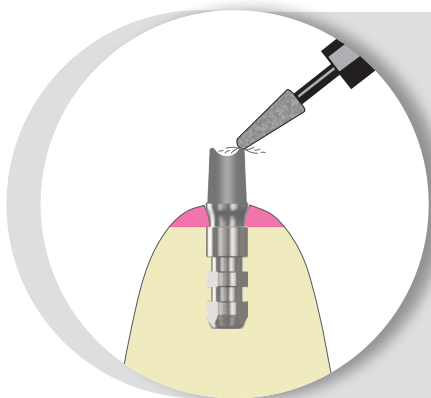

5. Return abutment to the model



Place the modified abutment on the mounted working model and make the final adjustments using a diamond bur. When the abutment margin is prepared it should be modified so the margin is 0.5 to 1.0 mm subgingival in the esthetic area and at gingival or supragingival in the non esthetic areas.

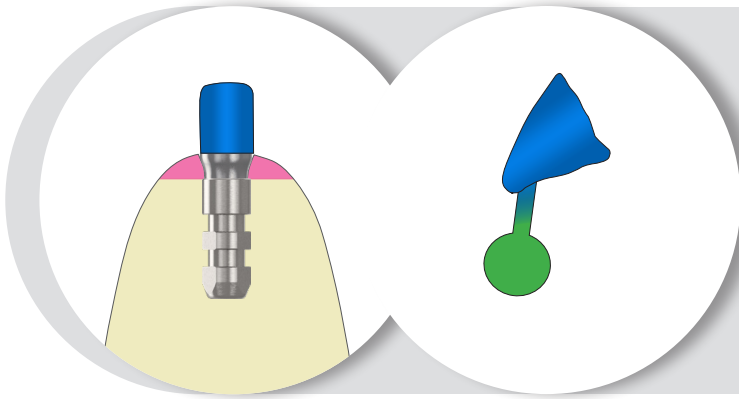

6. Wax and cast the metallic base of the crown L

Block-out the screw access hole from the prepared abutment and apply die spacer. Create wax crown coping over modified abutment following conventional procedures. Sprue, invest and cast the coping pattern in noble alloy according to the manufacturer's instructions.

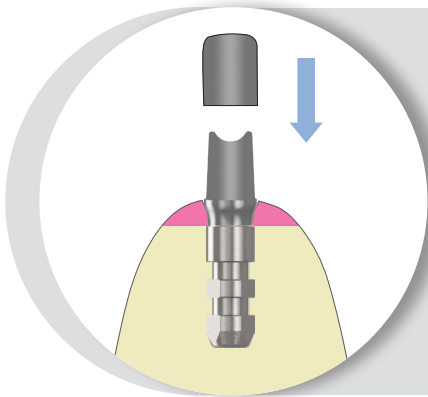

7. Divest and finish the coping L

Divest, fit, and finish the cast coping following conventional laboratory procedures in preparation for the porcelain application.

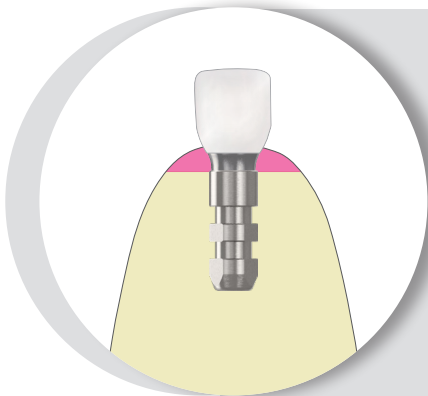

8. Apply porcelain L

Apply opaque and porcelain to the metal framework and complete the crown according to conventional laboratory procedures. Send the finished crown, the modified abutment and clinic screw to the clinician.

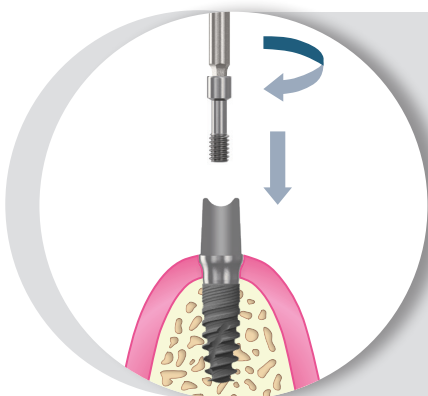

9. Clean and place modified abutment C

Sanitize modified abutment and crown following standard clinical procedures. Remove healing abutment or temporary prosthesis using a HEX-1.20 mm wrench. Make sure the implant platform is free of bone and soft tissue. Place the modified abutment and clinic screw, engaging the implant hex, and hand tighten using a HEX-1.20 mm wrench (Ref. KYL0F0128). Take a radiograph along the long axis of the implant to ensure the abutment is placed completely in the implant.

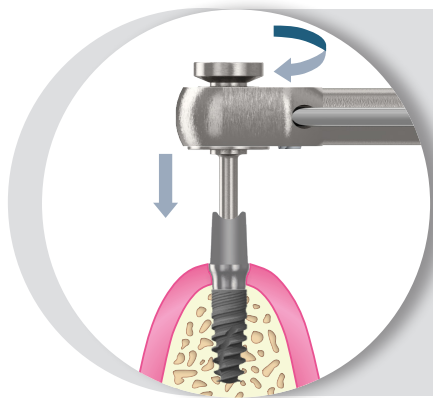

10. Final screw tightening

C

Tighten the clinic screw to **25 N•cm** using a HEX-1.20 mm wrench (Ref. KYLOF0128) coupled to TI ratchet wrench (Ref. KYLOF0113). Follow the instructions for use of TI ratchet wrench to apply torque accurately.

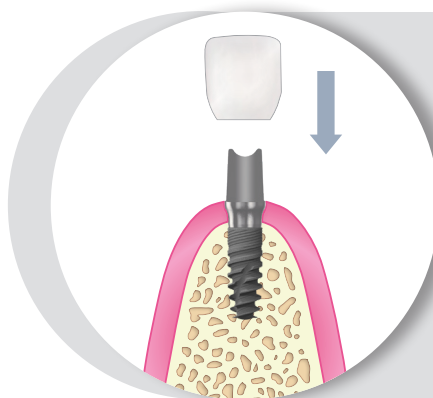

11. Cement the crown

C

Place a resilient material of choice (gutta-percha, silicone or temporary filling material) into the screw access hole and fill the remaining canal with composite or another material of choice. This allows for easy access to the abutment screw in the future. Place the final restoration onto the abutment and check the occlusion, the contacts and the contour. Modify if it is necessary and polish after making adjustments. Finally cement the crown following the manufacturer recommended procedures. Take a radiograph for the final prosthesis delivery records.

SCREW-RETAINED RESTORATIONS

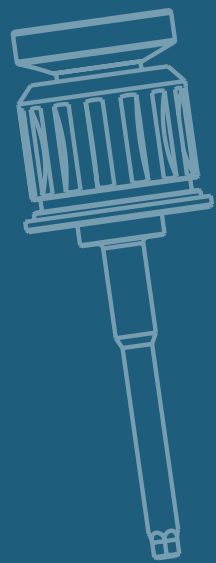

SCREW-RETAINED REST. OVER MULTI-ESTHETIC ABUT.



▶ FUNCTION

ME castables are the pieces that allow for hybrid or fixed-detachable restorations screwed onto multi-esthetic abutments, in partially or totally edentulous patients.

▶ REQUIRED MATERIAL



▶ PROCEDURE

C Clinician **L** Laboratory

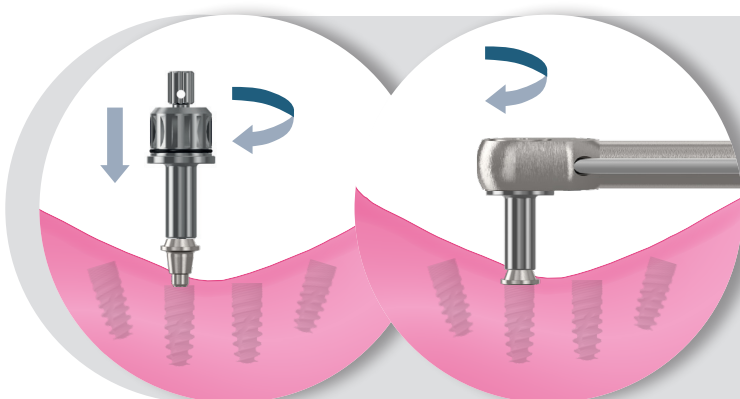

1. Select and thread the straight ME abutments **C**

Select the emergency height and diameter of the straight ME abutments based on the implant platform and the existing soft tissue thickness. Screw the selected abutments to the implants manually with the ME abutment wrench (Ref. KYL0F0180) and end the tightening with the wrench attached to the TI torque wrench using a torque of **30 N•cm**.

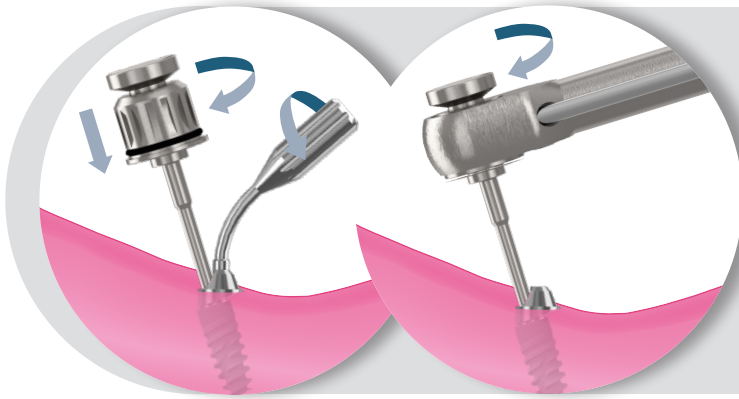

2. Select and thread the ME angled abutments C

Select the height and angle of the ME abutments depending on the angle and soft tissue thickness. Position the abutment and screw the ME angled abutment to the implant manually with the wrench for the ME angled abutment (Ref. KYLOF0130). Unscrew the abutment guide and finish the tightening with the wrench attached to the TI torque wrench using a torque of **20 N•cm**.

Note: The angled ME abutment screw is not removable since it works as an extractor.

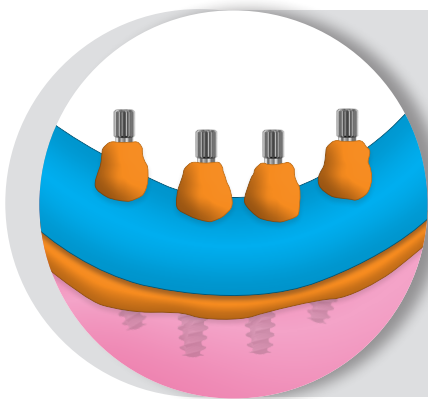

3. Impression taking on ME abutments C

Take the impression on the ME abutments with the open tray method following the procedures outlined in the corresponding section. Place the ME healing abutments on the multi-esthetic abutments using the HEX-1.20 wrench (Ref. KYLOF0128) and send the tray with the impressions to the laboratory.

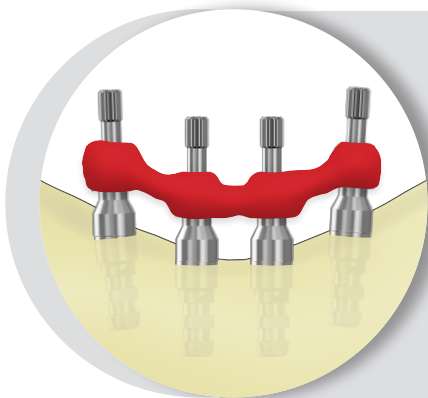

4. Create a verification jig L

Place the open-tray impressions copings for the ME on the model and screw them on the replicas with the large impression screw, using the HEX-1.20 wrench. Use dental floss or orthodontic wire to connect all the impressions. Apply resin or curable material with light on the wire or floss to splint together all the impressions copings. Retouch and soften the acrylic as necessary. Send the verification jig to the clinician to confirm that the adjustment is passive or otherwise, make appropriate modifications.

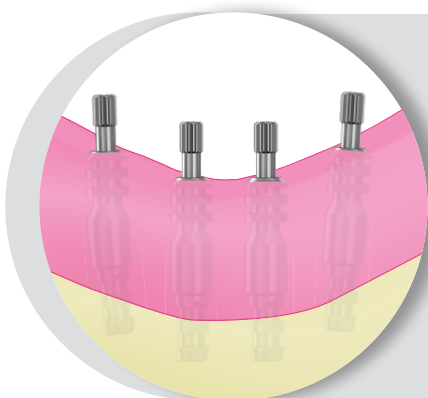

5. Create baseplate and wax occlusal rim L

Place the open-tray impression copings for the ME on the model and screw them on the replicas with the large impression screw, using the HEX-1.20 wrench. Place a sheet of material that is curable with light around the impression copings and then along the edentulous arch to create a base plate. Create a wax occlusal rim on the base plate that allows access to the screws. It is sufficient to attach the set to the model with two screws in the area of the cusps. Send the set to the clinician to make the interocclusal record.

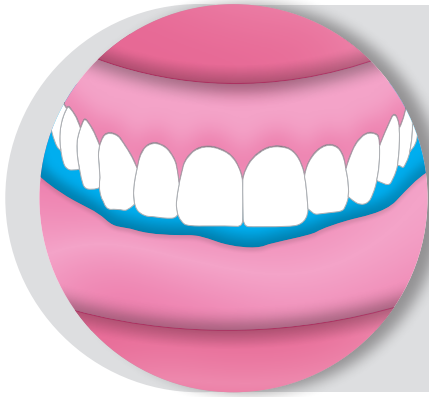

6. Make the interocclusal record

C

Remove the ME healing abutments with the appropriate HEX-1.20 mm wrench. Attach the assembly comprised by the base plate and the occlusal edge to the multi-esthetic abutments using the ME clinic screws tightened manually with a HEX-1.20 mm wrench. Contour the occlusal rim, mark the midline and smile line. Record the vertical dimension of the occlusion with bite registration material. Reposition the ME healing abutments on the multi-esthetic abutments to prevent the collapse of the soft tissue. Send to the laboratory.



7. Mount and set the teeth

L

Attach the denture base to the model and mount in the articulator together with its antagonist model to add the teeth and create the denture. Adjust the teeth so that the holes for access to the screws are free.

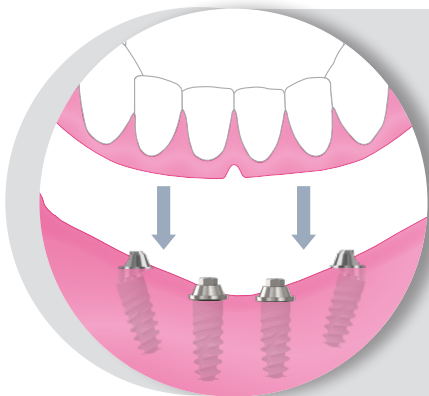

8. Trial denture try-in

C

Place the denture in the mouth and check occlusion, esthetics and phonetics. If necessary make new inter-occlusal records to modify it and retest.

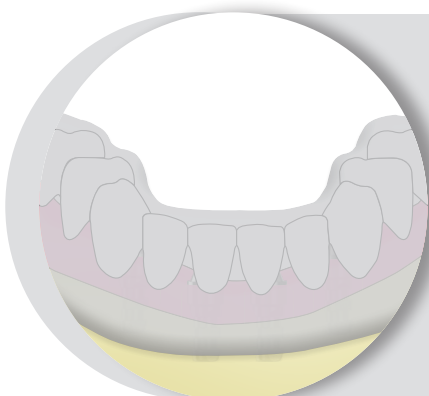

9. Make a silicone mask

L

Make a silicone mask of the labial area of the denture to record the position of the teeth and lip edges of the prosthesis for the model. Remove the wax teeth and place them in their position on the silicon mask, attaching them to it with setting wax.

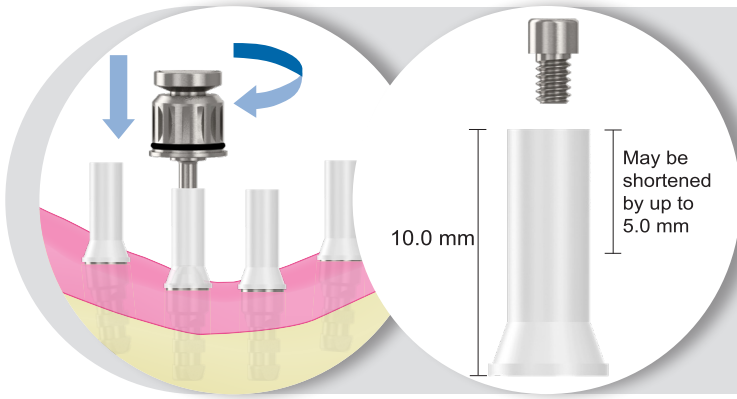

10. Place and modify ME castable



Place the ME castables on the ME replicas and tighten them with the screw manually using the corresponding HEX-1.20 wrench. Place the silicone mask with the teeth attached on the model and use it as a guide to modify the castables.

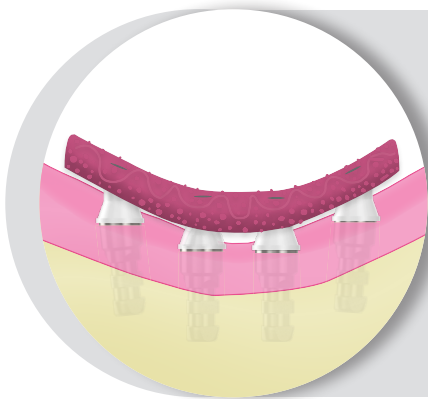

11. Design and wax the structure



Design and wax the structure that will maintain the position of the teeth. Leave the structure 2 to 3 mm above the soft tissue to facilitate proper hygiene. Complete the waxing and add retention elements to retain the acrylic.



12. Prepare and cast



Prepare the wax structure for the cast according to standard laboratory procedures. Cast the structure. Divest, finish and polish as needed.

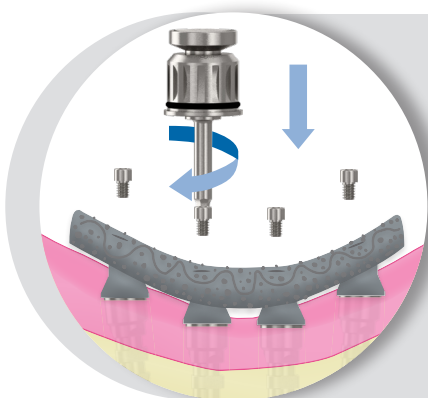

13. Check passivity



Place the framework on the model attaching it with ME screws and check the passivity of the structure. Cut and weld as necessary until the structure is passive.

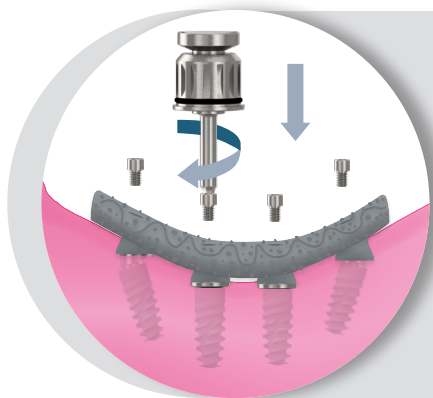

14. Try-in the framework

C

Remove the ME healing abutments with HEX-1.20 mm wrench. Place the structure on the multi-esthetic abutments and verify that it is placed passively. Start tightening the most distal screw and verify that the structure is adjusted to the ME abutments in all other connections. Continue placing the ME screws and checking the adjustment each time one is screwed. If when a screw is tightened the structure does not adjust properly it is not passive and needs to be cut and corrected in the laboratory.

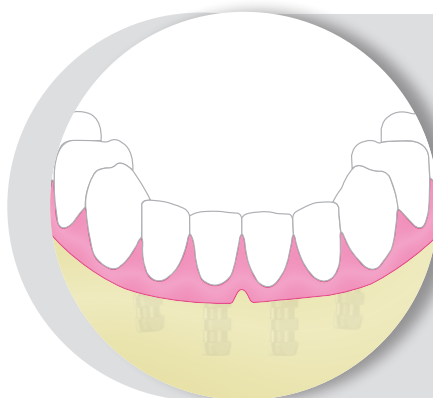

15. Create the denture

L

After checking the passivity of the structure form the teeth in wax following the conventional procedures for the manufacture of dentures. Send the hybrid denture to the clinician.

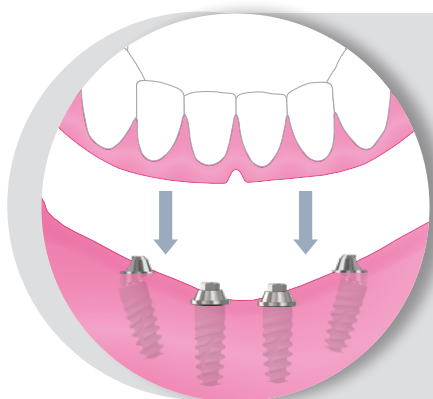

16. Try-in denture

C

Place the denture in the mouth again and check occlusion, esthetics and phonetics. If necessary make new inter-occlusal records to modify it and retest. Place the ME healing abutments on the multi-esthetic abutments again.

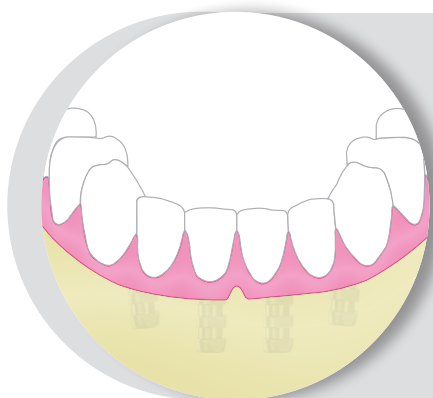

17. Process the denture

L

Once you have verified that everything is correct process denture following standard laboratory procedures to create the permanent denture.

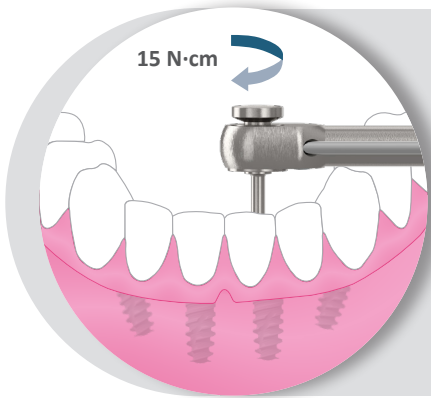

18. Final tightening of the denture

C

Carry out the final tightening of the ME clinic screws with the HEX-1.20 wrench attached to the TI ratchet wrench applying a torque of **15 N·cm**.

Important note: Do not exceed 15 N·cm to prevent the screw failure.

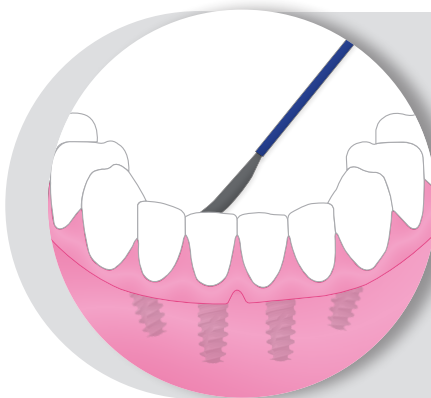

19. Seal the screw access holes

C

Seal the access holes for the screws.
Take a radiograph for the records.

SCREW-RETAINED REST. OVER BIOESTHETIC BASE



► FUNCTION

The BE castables are the pieces that will allow cement-screwed single restorations to be made on bioesthetic bases using the conventional casting technique.

► REQUIRED MATERIAL



► PROCEDURE



Clinician



Laboratory

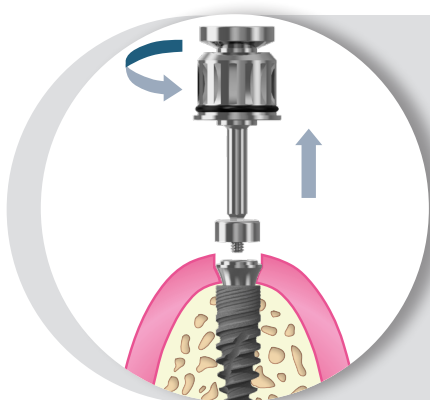

1. Remove the healing abutment



Remove the healing abutment from the BE base manually with the HEX-1.20 mm wrench (Ref. KYLOF0128).

Check that the BE base connection is free of bone or soft tissue.

Important note: Retighten the screw of the BE base to 25 N·cm.

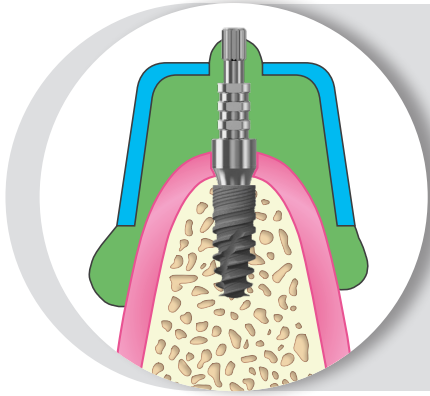

2. Impression coping

C

Make the impression coping of the implant using open tray (OT) technique following the procedures explained in the corresponding section and re-position the healing abutment.

Send the components to the lab.

Important note: Before replacing the healing abutment, retighten the screw of the BE base to 25 N-cm.

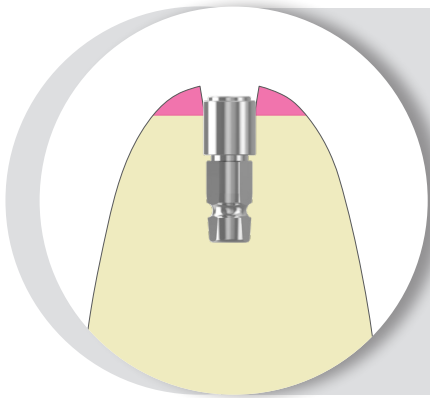

3. Fabricate the working model

L

Fabricate stone working model, model soft tissue and articulate the following conventional laboratory procedures.

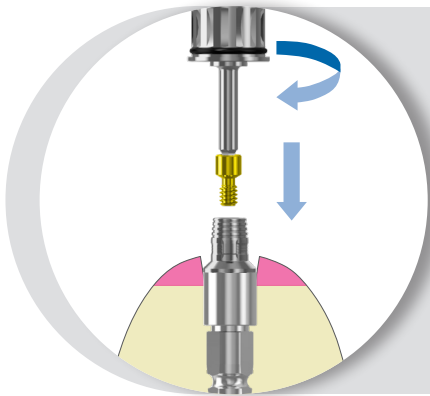

4. Place and screw the titanium base

L

Insert the titanium base into the replica, making sure it is oriented correctly and screw the BE laboratory screw manually with the Hex-1.20 mm wrench (Ref. KYL0F0128).

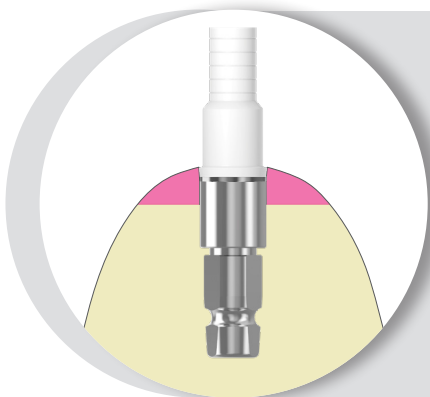

5. Place and modify castable

L

Place the castable on the titanium base and modify it to suit your needs.

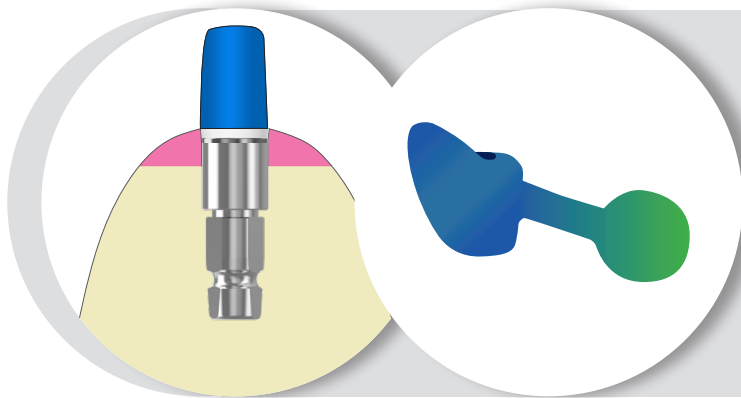

6. Wax and cast the metallic base of the crown

L

Block-out the screw access hole from the castable and apply die spacer. Create wax crown coping over modified castable following conventional procedures. Sprue, invest and cast the coping pattern in noble alloy according to the manufacturer's instructions.

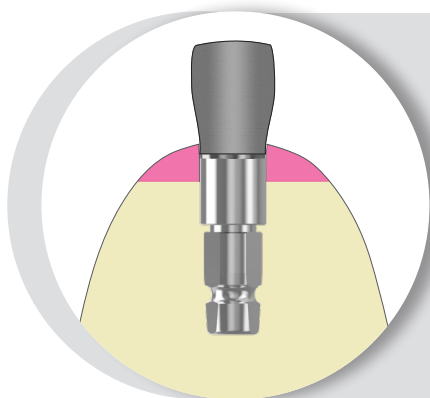

7. Touch up and prepare for porcelain

L

Unmold, remove the sprue, check the fit with the abutment and touch up following the usual procedures to prepare the porcelain application.

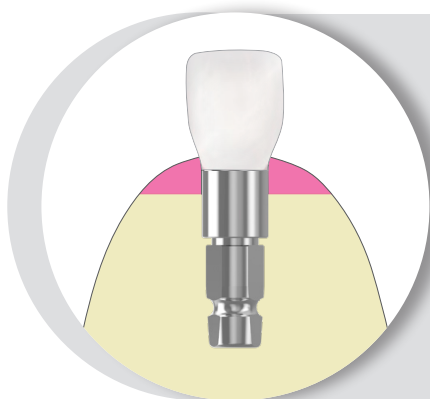

8. Apply porcelain

L

Apply opaque and porcelain to the metal framework and complete the crown according to conventional laboratory procedures.



9. Cement the crown

L

Cement the crown to the titanium base.
Send the finished crown and the BE screw to the clinician.

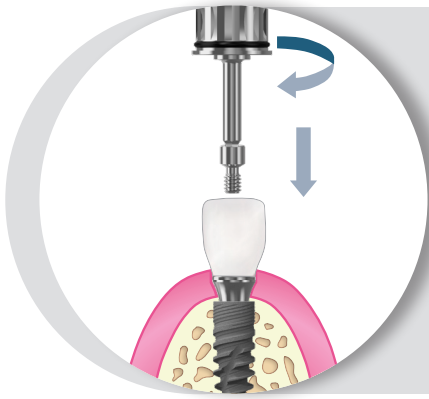

10. Clean and place the crown in mouth

C

Sanitize the crown following standard clinical procedures. Remove healing abutment or temporary prosthesis using a HEX-1.20 mm wrench. Make sure the BE base platform is free of bone and soft tissue. Place the titanium base with the crown and hand tighten with the BE screw using a HEX-1.20 mm wrench (Ref. KYL0F0128). Take a radiograph along the long axis of the implant to ensure the base is placed completely in the implant.

Important note: Retighten the screw of the BE base to 25 N·cm.

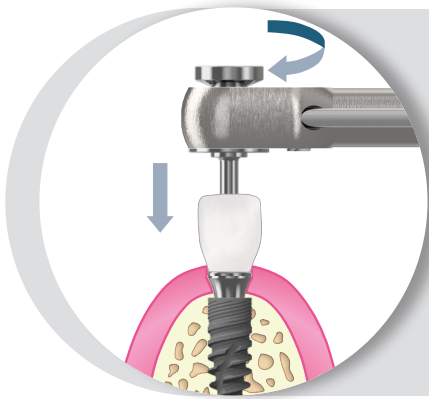

11. Final screw tightening

C

Tighten the BE screw to **15 N·cm** using a HEX-1.20 mm wrench (Ref. KYL0F0128) coupled to TI ratchet wrench (Ref. KYL0F0113). Follow the instructions for use of TI ratchet wrench to apply torque accurately.

OVERDENTURE RESTORATIONS

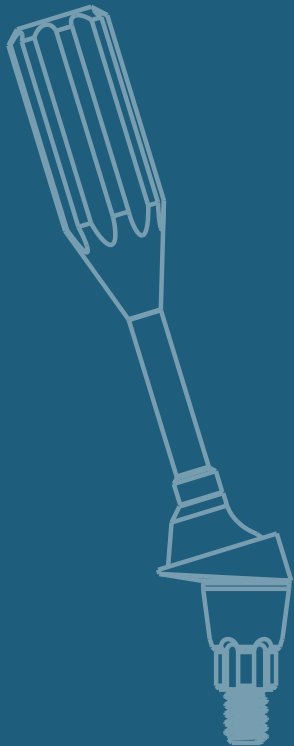

OVERDENTURE WITH EQUATOR* ABUTMENTS



► FUNCTION

EQUATOR abutments serve as retention elements to stabilize existing or newly manufactured whole or partial implant-supported overdentures.

► REQUIRED MATERIAL



Equator abutment



Retention



Container

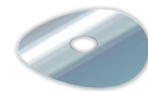

Protection disk



Equator abut.
wrench



Manual wrench
HEX-1.20



Insertion / removal tool
for caps



TI ratchet wrench

► PROCEDURE

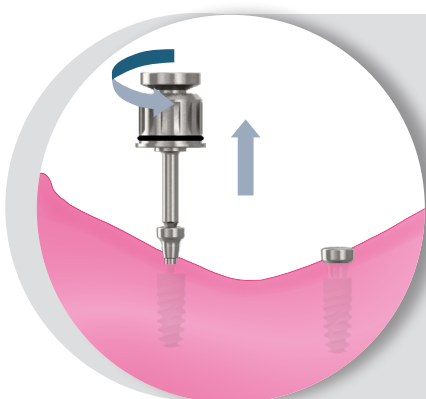

1. Remove the healing abutment

Manually remove the healing abutment from the implant using a HEX-1.20 mm wrench (Ref. KYL0F0128). Ensure that the implant connection is free of any bone debris or soft tissue.

* Equator abutments are manufactured by RHEIN'83 s.r.l.

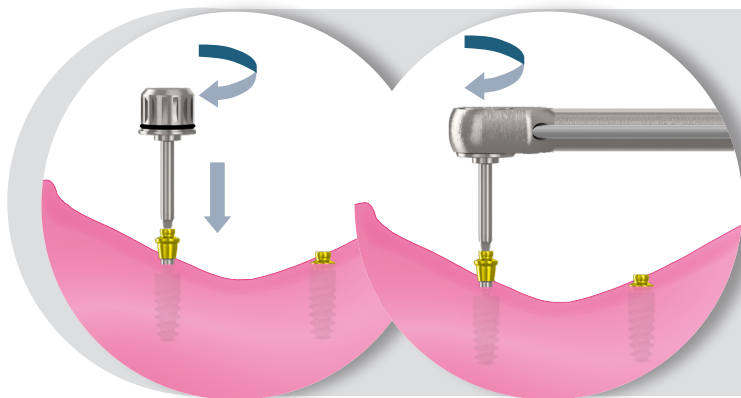

2. Select and screw the EQUATOR abutments

Select the height and diameter of the EQUATOR abutments based on the implant platform and the existing soft tissue thickness. Screw the abutments to the implants manually with the EQUATOR abutment wrench (Ref. KYL0F0132) and finish tightening with the wrench attached to the TI torque wrench using a torque of **30 N·cm**. Take a radiograph along the axis of the implant to ensure that the settlement is correct.



3. Mark and make accommodations for the containers

Make a mark in the coronal part of the EQUATOR abutments with a permanent marker and transfer their position to the denture. Perform the recesses in the marks made to accommodate the retention containers, leaving at least 0.25 mm of clearance between the denture and the containers to prevent excessive pressure on the implants. Make a few lingual holes so that the excess acrylic can exit.

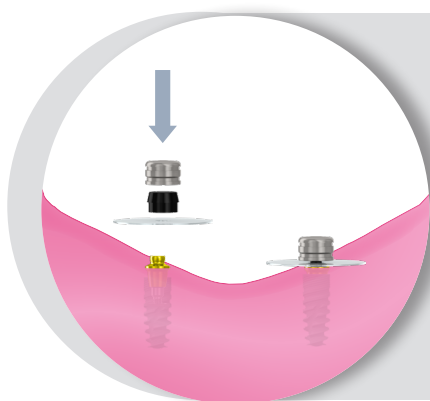

4. Place the retentions in the EQUATOR abutments

Insert the black laboratory retentions in the containers with the retention insertion wrench (Ref. RH485IC). Place a protection disc between the abutment and the container to protect the soft tissues from the acrylic, and insert a container in each EQUATOR abutment.

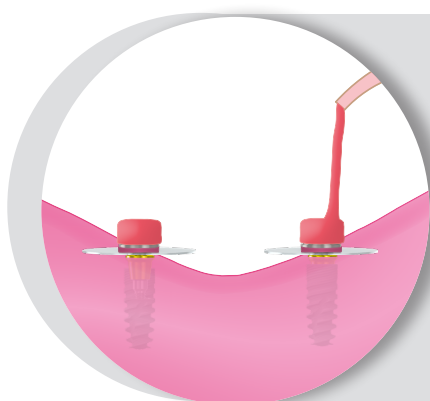

5. Apply the acrylic resin

Apply a small amount of acrylic resin, either cured with light or self-curable, in accommodations made in the teeth and around containers of retentions.

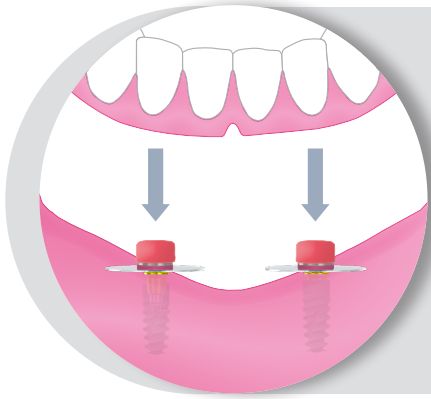

6. Place the denture

Place the denture in the mouth again and make the patient occlude, maintaining a proper relationship with the opposing arch. Maintain the denture in a passive position without compressing the soft tissue while the resin hardens.

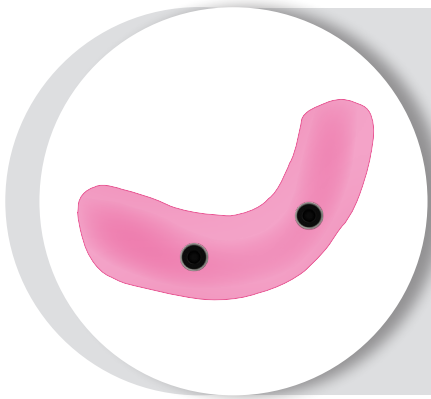

7. Remove denture and adjust

Once the acrylic resin is cured, remove the denture and the protection discs from the mouth. Fill the holes and remove any remaining excess acrylic around the containers and from the holes of the lingual overflows. Polish the denture.

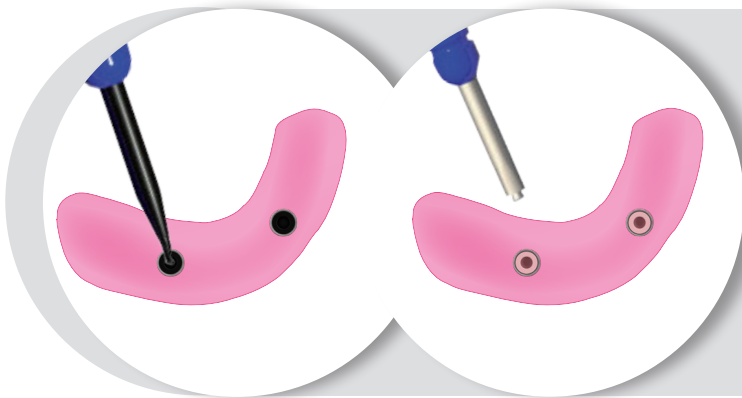

8. Check retention and adjust

Remove the laboratory retention and place the proper retention. Check denture retention on the abutments and adjust according to the needs. Use retention extractor (Ref. RH4851C) to remove the retentions and the insertion wrench (Ref. RH4851C) to place the new ones.

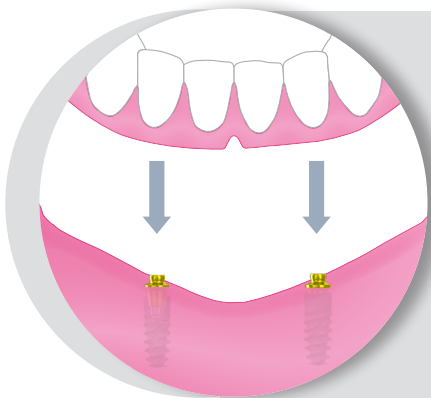

9. Place the denture and finish

Place the denture in the patient's mouth again. Modify the occlusion and the soft tissue side as necessary and polish again after making the modifications. Ensure that the patient is able to remove and install the overdenture properly.

OVERDENTURE WITH BARS ON ME ABUTMENTS



▶ FUNCTION

ME castables are the parts that will enable carrying out implant-supported screw-retained bar with an overdenture on multi-esthetic abutments.

▶ REQUIRED MATERIAL



▶ PROCEDURE

C Clinician **L** Laboratory

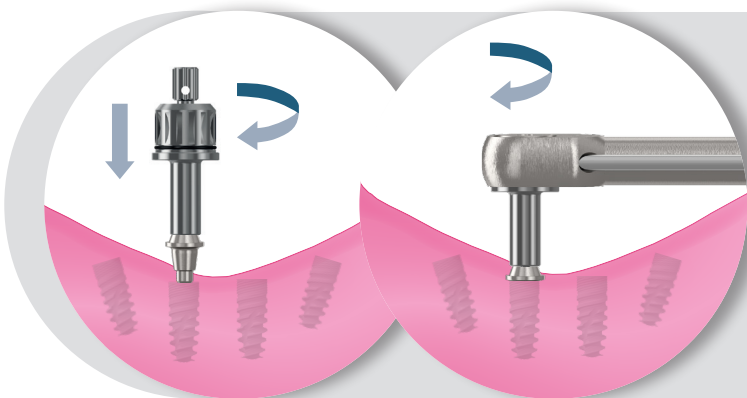

1. Select and thread the ME straight abutments **C**

Select the emergency height and diameter of the straight ME abutments based on the implant platform and the existing soft tissue thickness. Screw the selected abutments to the implants manually with the ME abutment wrench (Ref. KYLOF0180) and end the tightening with the wrench attached to the TI torque wrench using a torque of **30 N·cm**.

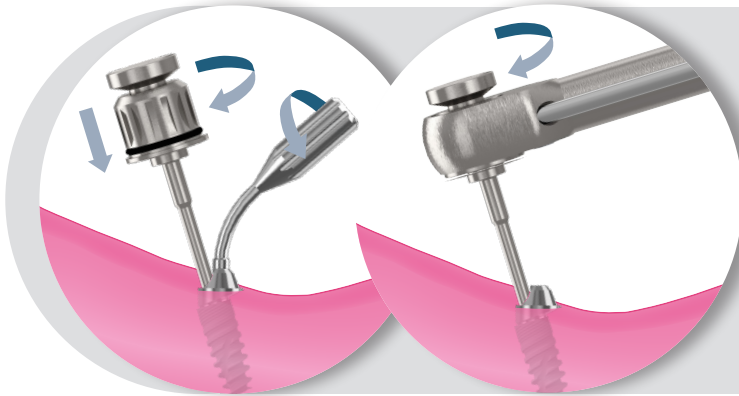

2. Select and thread the ME angled abutments C

Select the diameter and angle of the ME abutments depending on the implant angle and platform. Place the abutment and screw the angled ME abutment to the implant manually with the wrench for the angled ME abutment (Ref. KYLOF0130). Unscrew the abutment guide and finish the tightening with the wrench attached to the TI torque wrench using a torque of **20 N•cm**.

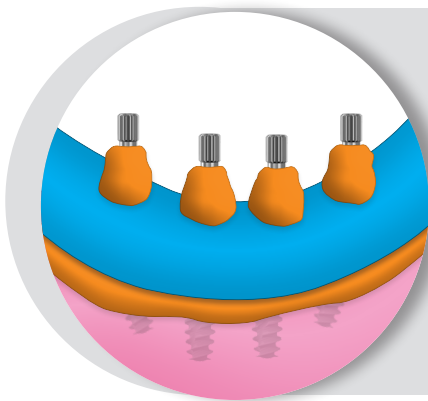

3. Impression coping on ME abutments C

Take the impression on the ME abutments with the open tray method following the procedures outlined in the corresponding section. Place the ME healing abutments on the multi-esthetic abutments using the HEX-1.20 wrench (Ref. KYLOF0128) and send the tray with the impressions to the laboratory.

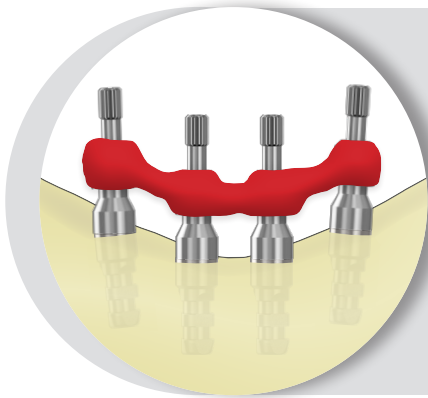

4. Create a verification jig L

Place the open-tray impressions for the ME on the model and screw them on the replicas with the large impression screw, using the HEX-1.20 wrench. Use dental floss or orthodontic wire to connect all the impressions. Apply resin or curable material with light on the wire or floss to splint together all the impressions. Adjust and polish the acrylic as necessary. Send the verification template to the clinician to confirm that the adjustment is passive or otherwise, make appropriate modifications.

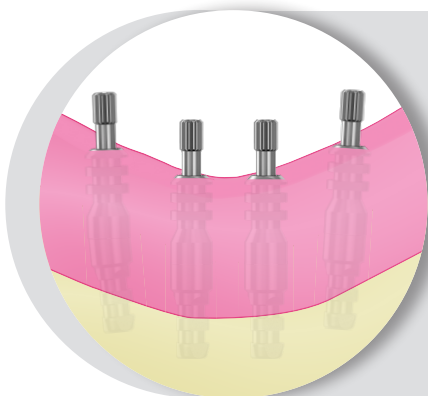

5. Create baseplate and wax occlusal rim L

Place the open tray impression copings for the ME on the model and screw them to the replicas with the long impression screw, using the HEX-1.20 wrench. Place a photocurable sheet around the impression copings and then along the edentulous arch to create a base plate. Create a wax occlusal rim on the base plate that allows access to the screws. It is sufficient to attach the assembly to the model with two screws in the area of the cusps. Send the assembly to the clinician to make the interocclusal record.

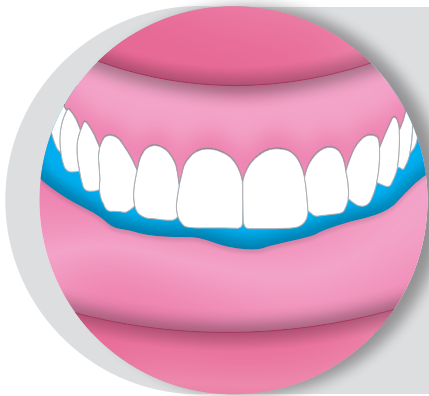

6. Make the interocclusal record

C

Remove the ME healing abutments with the appropriate HEX-1.20 mm wrench. Attach the assembly comprised by the base plate and the occlusal rim to the multi-esthetic abutments using the ME clinic screws tightened manually with a HEX-1.20 mm wrench. Contour the occlusal rim, mark the midline and smile line. Record the vertical dimension of the occlusion with bite registration material. Reposition the ME healing abutments on the multi-esthetic abutments to prevent the collapse of the soft tissue. Send to the laboratory.



7. Mount and set the teeth

L

Attach the denture base to the model and mount in the articulator together with its antagonist model to add the teeth and create the denture. Adjust the teeth so that the holes for access to the screws are free.

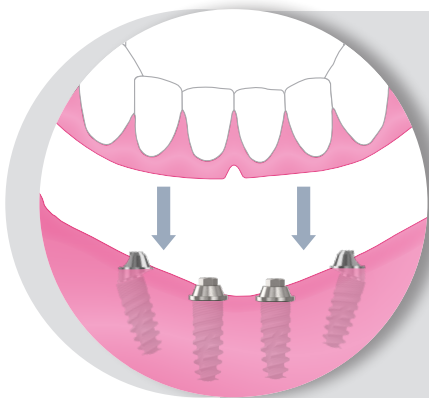

8. Trial denture try-in

C

Place the denture in the mouth and verify occlusion, esthetics and phonetics. If necessary make new inter-occlusal records to modify it and try-in again.

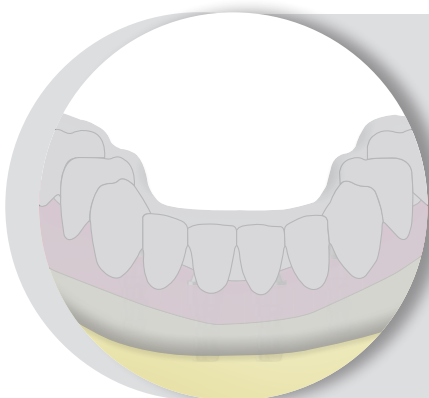

9. Make a silicone mask

L

Make a silicone mask of the labial area of the denture to record the position of the teeth and lip edges of the prosthesis for the model. Remove the teeth from the wax and place them in the silicone mask by fixing them with fixed wax.

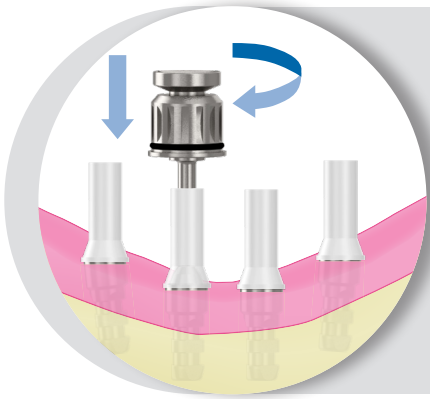

10. Place and modify ME castables



Place the Me castables on the ME replicas and tighten them with the screw manually using the corresponding HEX-1.20 wrench. Place the silicone mask on the model and use it as a guide to modify the castables.

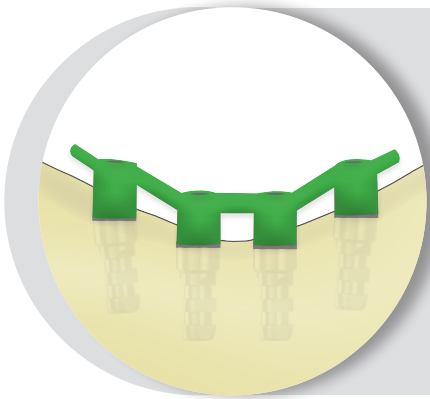

11. Design and wax the bar



Design the bar for the overdenture using a wax bar or preformed bars incorporating the castables to the structure. Check the position of the fittings, the height of the bar and the functional requirements.

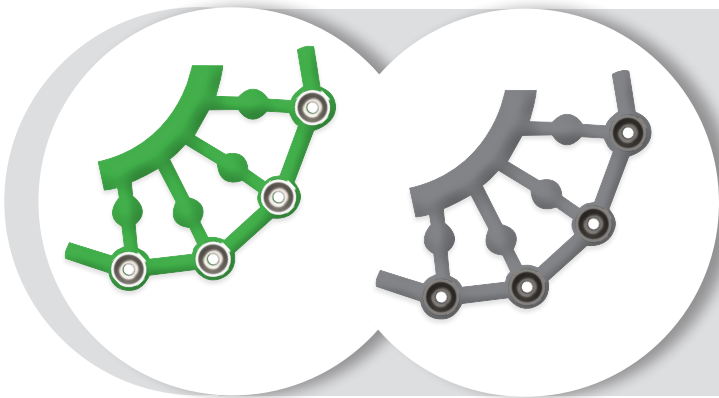

12. Prepare and cast



Prepare the wax structure for the cast according to standard laboratory procedures. Cast the structure. Divest, finish and polish as needed.

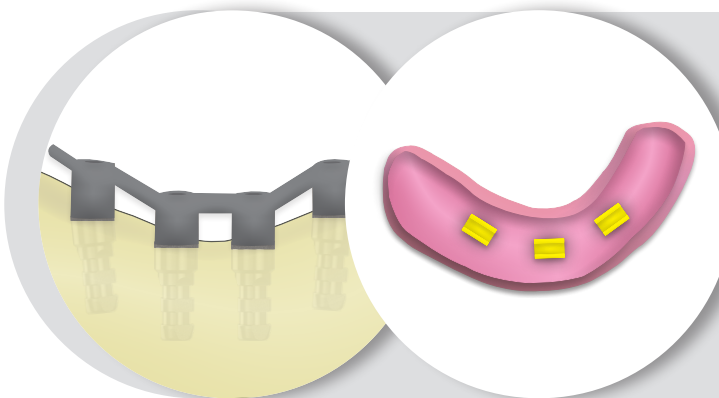

13. Check passivity and add clips



Place the bar in the model, attaching it with ME screws and check the passivity of the structure. Cut and weld as necessary until the structure is passive. Place the retentive clips in the denture following the conventional laboratory procedures.

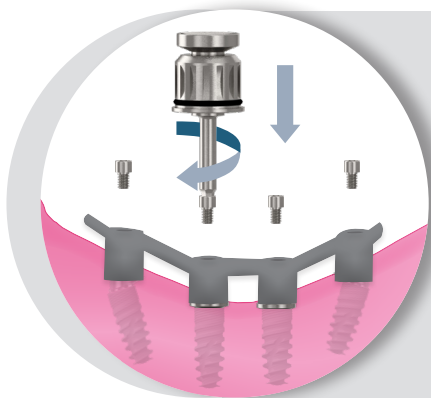

14. Try in the bar

C

Remove the ME healing abutments with a HEX-1.20 mm wrench. Place the bar on the multi-esthetic abutments and verify that the bar is placed passively. Start tightening the most distal screw and verify that the bar adjust to the ME abutments in all other connections. Continue placing the ME screws and checking the adjustment each time one is screwed. If when a screw is tightened the bar does not adjust properly the bar is not passive and needs to be cut and corrected in the laboratory.

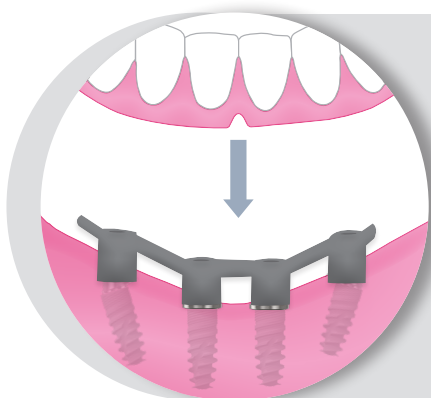

15. Try in the denture

C

Place the denture in the mouth again and check occlusion, esthetics and phonetics. If necessary make new inter-occlusal records to modify it and try-in again.

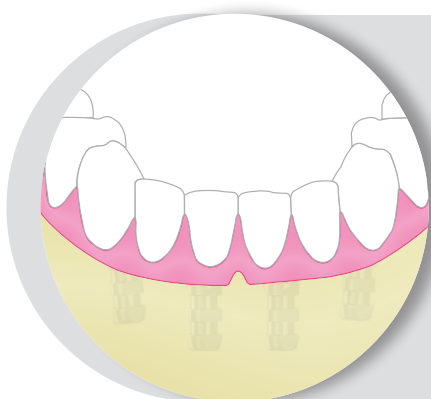

16. Process the denture

L

Once you have verified that everything is correct process denture following standard laboratory procedures to create the permanent denture.

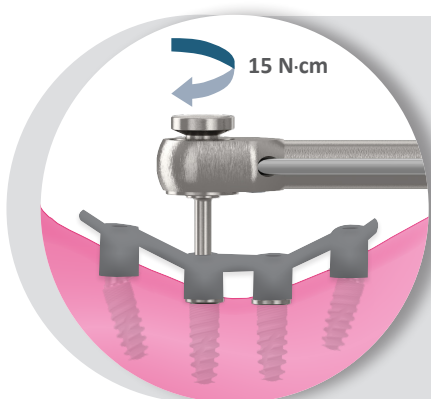

17. Final tightening of the denture

C

Carry out the final tightening of the ME clinic screws with the HEX-1.20 wrench attached to the TI ratchet wrench applying a torque of 15 N•cm.

Important note: Do not exceed 15 N•cm to prevent the screw failure.

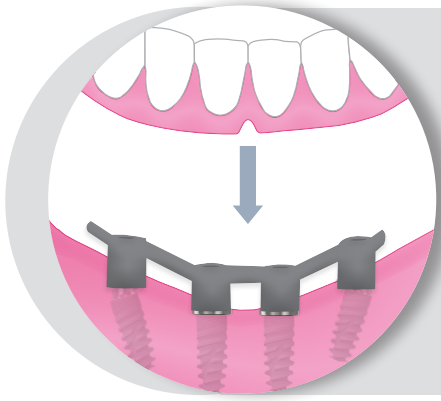

18. Place the denture

C

Place the denture on the bar and carry out the last verification. Take a radiograph for the records.



 GMI Dental Implantology, S.L.
"Pol. Ind. El Segre" C/ Enginyer Mies 705 B - 25191 Lleida (Spain)
Tel: +34 973 184 350 - info@gmidental.com - www.gmidental.com

